

Traveller TV



Instruction Book

Contents

SAFETY INFORMATION.....	3
Headphone Warning.....	4
Where to install.....	4
LED Screen.....	4
Unit and Accessories.....	5
Unit and Started.....	5
Front view.....	5
Remote Control.....	7
Remote control instructions.....	7
Remote control instructions.....	8
Installaing Batteries in the Remote Control.....	9
Using the Remote Control.....	9
Aerial connection.....	9
Connecting the TV Antenna.....	9
Connecting external devices.....	9
HDMI Lead.....	9
VGA Cable.....	9
CONNECTIONS.....	11
PC connection.....	11
VGA,HDMI PC Connection.....	11
Satellite connection.....	11
Connecting Video camera and Video recorder.....	12
Connecting a Digital Audio Receiver.....	12
Connecting an audio system.....	12
Connecting a DVD player.....	13
HDMI Connection.....	13
USB Conntion.....	13
AV Connection.....	14
YPbPr Connection.....	14
TV OPERATION AND SYSTEM SETUP.....	15
Picture Menu.....	17
SOUND Menu.....	19
Channel.....	20
Feature.....	24
Setup.....	32
How to user Record.....	37
How to user Time shift.....	41
Hotel Mode.....	42
MEDIA OPERATION.....	44
Photo.....	45
Music.....	46
Movie.....	47
e-Book.....	47

How to use Miracast to mirror from mobile to TV.....	49
DVD Operation.....	50
TROUBLE SHOOTING GUIDE.....	53
TECHNICAL SPECIFICATIONS.....	53
Wall Mounting.....	54
Waste Electrical Recycling.....	54

Introduction

Thank you for purchasing this LED TV which has been designed and manufactured to give you many years of trouble free service.

You may already be familiar with using a similar product but please take time to read these instructions which have been written to ensure you get the very best from your purchase.

HDMI

HDMI (High Definition Multimedia Interface) is the next generation of digital interface. Unlike conventional connections, it transmits uncompressed digital and audio signals using a single cable. This TV supports high-definition video input via the HDMI socket on the back of the TV.

Safety is important

To ensure your safety and the safety of others, please read the safety precautions BEFORE you operate this product.

Disclaimer

The illustrations of the LCD-TV, accessories and menus shown in this User's Manual may differ from the actual product.

SAFETY INFORMATION

IMPORTANT SAFETY INSTRUCTIONS - READ CAREFULLY BEFORE USE.

Take note of the following safety information which appears on the back of the TV.



CAUTION: TO PREVENT ELECTRICAL SHOCK, DO NOT REMOVE ANY COVER SCREWS, NO USER SERVICEABLE PARTS INSIDE, REFER SERVICING TO QUALIFIED SERVICE PERSONNEL.



This symbol indicates that there are important operating maintenance instructions in the literature accompanying this unit.



This symbol indicates that dangerous voltage constituting a risk of electric shock is present within this unit.

Keep these instructions

- Do not use this TV near water.
- Clean only with a slightly damp cloth.
- Do not block any ventilation openings.
- Install in accordance with the supplied Quick Start Guide and this User Guide.
- Protect the power chord from being walked on or pinched, particularly at plugs, and the point where it exits from the TV.
- Do not allow the power chord to overhang the edge of a table.
- Unplug this TV during lightening storms or when unused for long periods of time.



WARNING! TO REDUCE THE RISK OF FIRE OR ELECTRICAL SHOCK, DO NOT EXPOSE THIS TV TO RAIN OR MOISTURE. THE TV MUST NOT BE EXPOSED TO DRIPPING AND SPLASHING AND NO OBJECTS FILLED WITH LIQUIDS SHOULD BE PLACED ON THE TV.

NOTE: No naked flames such as candles should be placed on the TV.

NOTE: When displaying the same still picture for more than 2 hours without any interruption, the picture contours of the continuously displayed contents may remain visible on screen, i.e. a persistent image remains. The same applies, when displaying for more than 2 hours:

- the same background/wallpaper
- logos, video games, computer images, Teletext
- contents with a non-filling aspect ratio (e.g. 4:3 format)

These do not represent any malfunction and will not be covered by the manufacturer's warranty

This unit has been produced according to all current safety regulations. The following safety tips should safeguard users against careless use and the dangers connected with such use.

- Although this appliance has been carefully manufactured and rigorously checked prior leaving the factory, as with all electrical appliances it is possible for problems to develop. If you notice smoke, an excessive build up of heat or any other unexpected phenomena, you should disconnect the plug from the mains power socket immediately.
- Ensure that the unit is sufficiently ventilated! Never place next to or underneath curtains!
- The mains plug or appliance coupler is used as the disconnect device, the disconnect device shall remain readily operable.
- This set should only be connected to a mains power supply which matches that stated on the label on the rear of the TV - do not attempt to connect it to any other type of supply.
- The socket - outlet must be installed near the equipment and easily accessible.
- To prevent overload, don't share the same mains supply socket with too many other items of equipment.
- Apparatus with Class 1 construction shall be connected to a mains socket outlet with a protective earth connection.
- Keep away from rodents. Rodents enjoy biting into electric flexes.
- Always hold the plug when pulling out the plug from the mains supply socket. Do not pull on the flex, the flex can become overloaded and cause a short circuit.
- Set up the unit so that no one is able to trip over the flex.
- Do not place heavy items on the flex, which may damage it.
- Take note that the flex cannot be reached and pulled by young children, avoiding injury.
- Do not set up the unit near to heat sources. The casing and the flex could be damaged by the impact of heat.
- The screen is made of plastic and can break if damage is done to it. Be careful when collecting sharp edged plastic splinters to avoid injury.
- Avoid placing the unit on any surfaces that may be subject to vibrations or shocks.
- To protect the unit during a thunderstorm unplug the AC power cable and disconnect the aerial. Caution: Do not touch the aerial (RF) connector.
- When you leave your home for long periods of time, unplug the AC power cable for safety reasons.
- The unit becomes warm when in operation. Do not place any covers or blankets on the unit in order to prevent overheating. The ventilation holes are not to be blocked. Do not set up near radiators. Do not place in direct sunshine. When placing on a shelf leave 5 cm (2") free space around the whole unit.

- Do not allow water or moisture to enter the TV. Do NOT use in wet or moist areas such as Bathrooms, steamy kitchens or near swimming pools.
- Do not use this unit when moisture condensation may occur
- Any repairs must be carried out by qualified personnel only.
- Do not open this unit. A non-expert attempting to repair the unit could be dangerous and potentially cause a fire hazard.
- Liquids spilt into the unit can cause serious damage. Switch the set OFF and disconnect the mains power supply, then consult a qualified service person before attempting to use the unit again.
- Do NOT remove the safety covers. There are no useable or serviceable parts inside. You may invalidate the warranty. Qualified personnel must only service this apparatus.
- Do NOT tap or shake the screen, you may damage the internal circuits. Take good care of the remote control, do not drop.
- Never place hot objects or open flame sources on or close to the TV.
- High temperatures can melt plastic and lead to fires.
- To clean the TV use a soft dry cloth. Do NOT use solvents or petrol based fluids. For stubborn stains, you may use a damp cloth with dilute detergent.

Headphone Warning



Loud music can damage your hearing irreversibly, therefore do not set the volume to a high level when listening through headphones, particularly for lengthy listening periods.

Where to install

Locate the television away from direct sunlight and strong lights, soft indirect lighting is recommended for comfortable viewing. Use curtains or blinds to prevent direct sunlight falling on the screen. Place the TV on a sturdy platform of which the surface should be flat and steady. This will prevent it from falling over. Make sure the television is located in a position where it cannot be pushed or hit by objects, as pressure will break or damage the screen, and so that small objects cannot be inserted into the ventilation slots or openings in the cabinet.

LED Screen

The LED display panels are manufactured using an extremely high level of precision technology, however sometimes some parts of the screen may be missing picture elements or have luminous spots. This is not a sign of malfunction.

Unit and Accessories

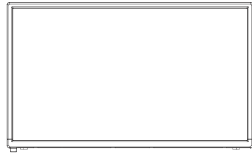

TV set



Remote Control



Batteries for Remote Control



Quick Start Guide



User Guide



Mains adapter



Car adapter



Stand

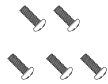

Screws (supplied)
5 x ST4 x 12

Getting Started

Front view

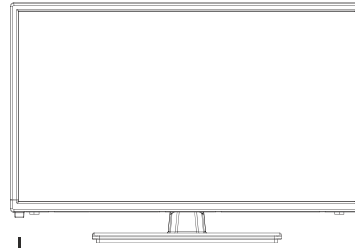

LED Indicator
Remote Control Window
(keep clear)



Packaging materials are not toys. Please keep away from children. Plastic bags can cause suffocation when pulled over the head.

Note about digital TV: Digital TV (DVB) is available only where digital terrestrial television (DVB-T) is broadcast or where a compatible cable TV service (DVB-C) is provided. Please ask your dealer if you need further information about the local availability of these services. DVB-T is the standard for terrestrial digital TV and DVB-C designates the digital cable TV service. Although this TV set conforms with all current DVB-T and DVB-C standards, we cannot guarantee compatibility with any future digital terrestrial DVB-T and DVB-C signals. Some cable TV providers charge additional fees and external hardware is required for their offer, and a subscription for the related services may be necessary. Some digital TV functions may be limited to specific regions and for DVB-C it is possible that the device will not perform as expected with certain providers. For more information, please do not hesitate to contact our Customer Service.

The parts

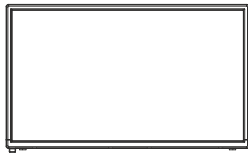

TV set



Stand

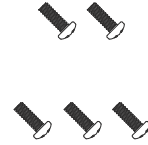

Screws(supplied)
5 x ST4 x 12

Installation

Place the TV face down on a soft and flat surface (blanket, foam, cloth, etc.) to prevent any damage to the TV.

Put the stand to the neck of the TV set as shown below.

1. Fix the base stand to the TV body as image 1.

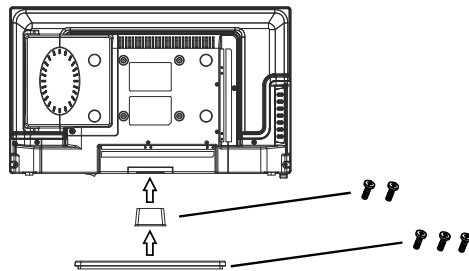

image 1

2. Fix the base stand to the TV body with screws.

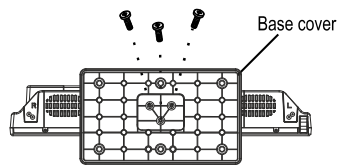
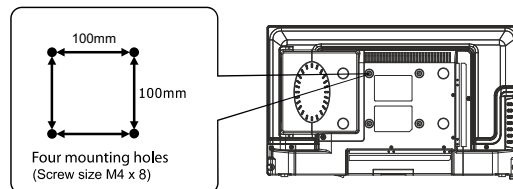

image 2

This unit is VESA-Compliant and designed to be wall mounted with a VESA-Compliant 100 x 100mm mounting kit.

Mount this according to the instructions of the wall bracket (not supplied)



Remote Control

Remote control instructions

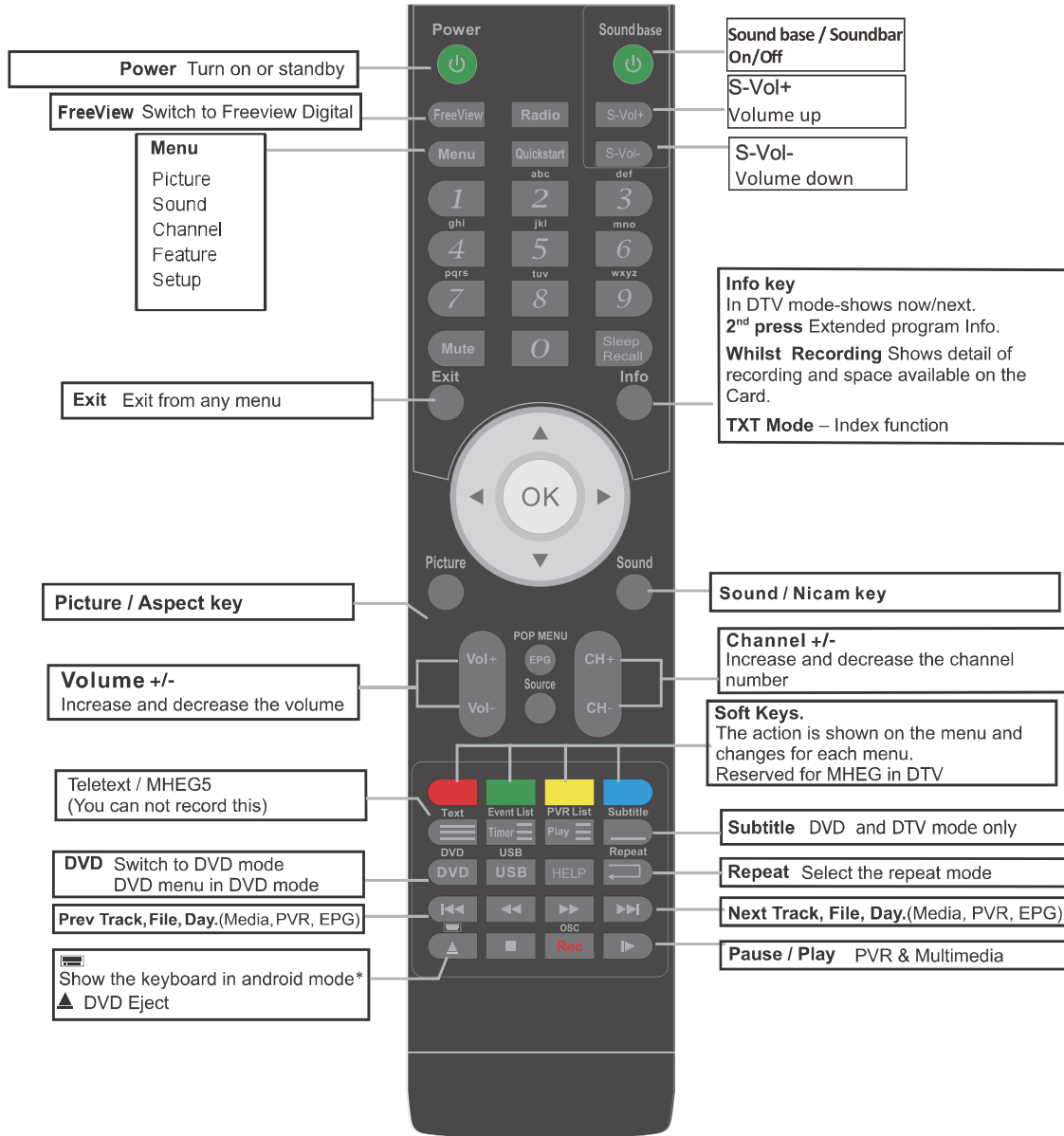

*Dependant on Model

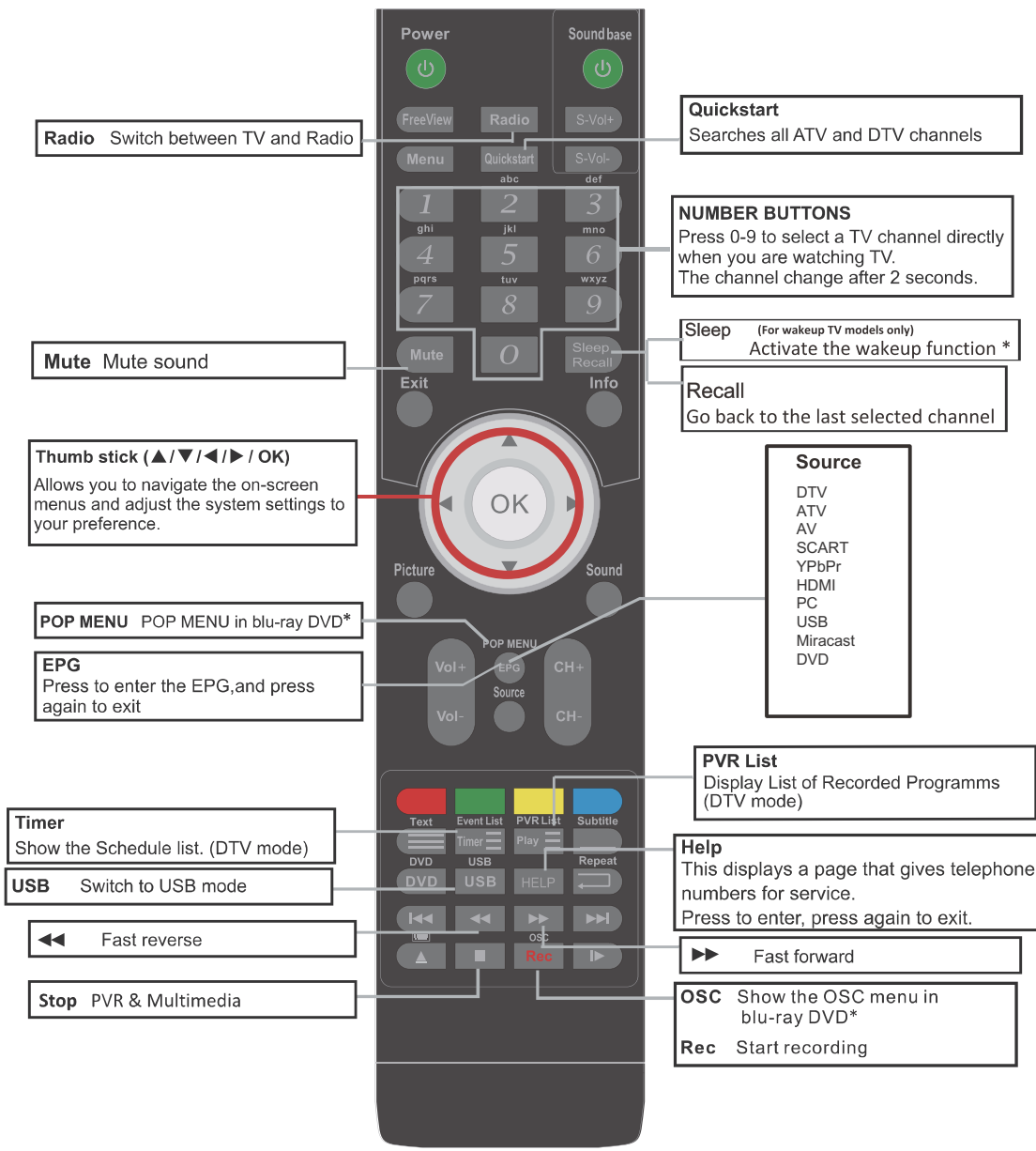

*Dependant on Model

Installing Batteries in the Remote Control

1. Remove the battery compartment cover at the rear of the remote control by pushing the retaining clip forward and pulling up.
2. Install the supplied batteries, ensuring the polarity matches what is shown in the battery compartment.
3. Replace the battery compartment cover.

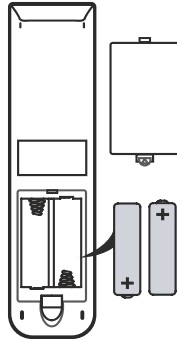

Using the Remote Control

To use the remote control point it at the TV and press the required buttons. You must be within 6 meters and at an angle of less than 30 degrees from the center of the TV.

NOTE: Sunshine or other strong light sources may interfere with the signal from the remote control. In this situation turn the TV away from the light source.



WARNING! DO NOT LEAVE BATTERIES IN THE REMOTE CONTROL FOR EXTENDED PERIODS AS THEY CAN LEAK OR CORRODE CAUSING DAMAGE TO THE REMOTE CONTROL. CHECK THEM PERIODICALLY AND REPLACE THEM AS REQUIRED.



WARNING! DO NOT MIX BATTERY TYPES. WHEN INSERTING BATTERIES, REPLACE ALL BATTERIES AT THE SAME TIME. DO NOT MIX OLD AND NEW BATTERIES.



WARNING! EXHAUSTED BATTERIES MUST BE TREATED WITH CARE AND DISPOSED OF ACCORDING TO ANY SAFETY OR RECYCLING REGULATIONS IN FORCE IN YOUR LOCAL AREA, NEVER DISPOSE OF BATTERIES INTO GENERAL WASTE, OR FIRE.



WARNING! NEVER EXPOSE BATTERIES TO EXCESSIVE HEAT SUCH AS SUNSHINE, FIRE OR THE LIKE.

Aerial connection

WARNING! ENSURE THE TV AND ALL ANCILLARY EQUIPMENT IS UNPLUGGED FROM THE MAINS BEFORE MAKING ANY CONNECTIONS!

Connecting the TV Antenna

Connect the TV antenna to the aerial socket with a 75 ohm co-axial plug. For best results use a high gain TV aerial, preferably roof or loft mounted.

- To improve picture quality in a poor signal area, purchase and install a signal amplifier.
- If the antenna needs to be split for two TVs, use a 2-Way Signal Splitter (not supplied).

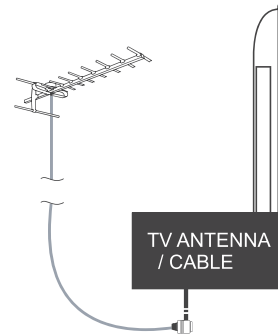

Connecting external devices

This instruction manual shows the simplest and most effective way of connecting your TV to ancillary equipment. Alternate methods are listed below.

HDMI Lead

You can connect this TV to a compatible device using a HDMI lead. This method will give the best picture.

Connect the cable from the HDMI equipment to the TV HDMI socket.

VGA Cable

You can use your TV as a monitor for your personal computer by using a VGA cable. Sound from your personal computer may also be played through the TV.

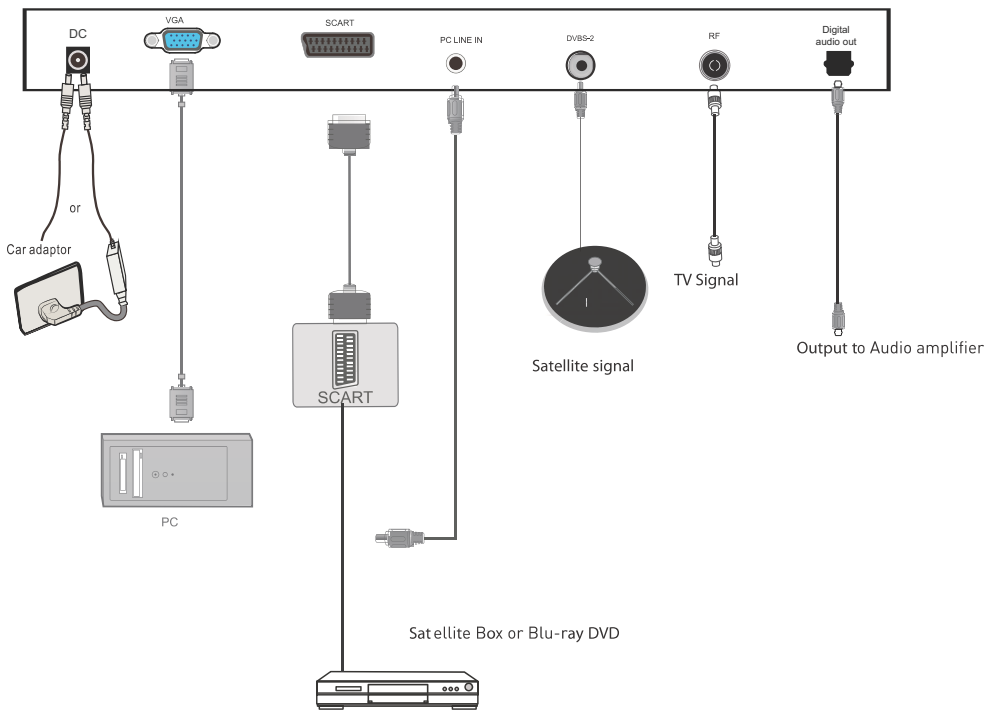
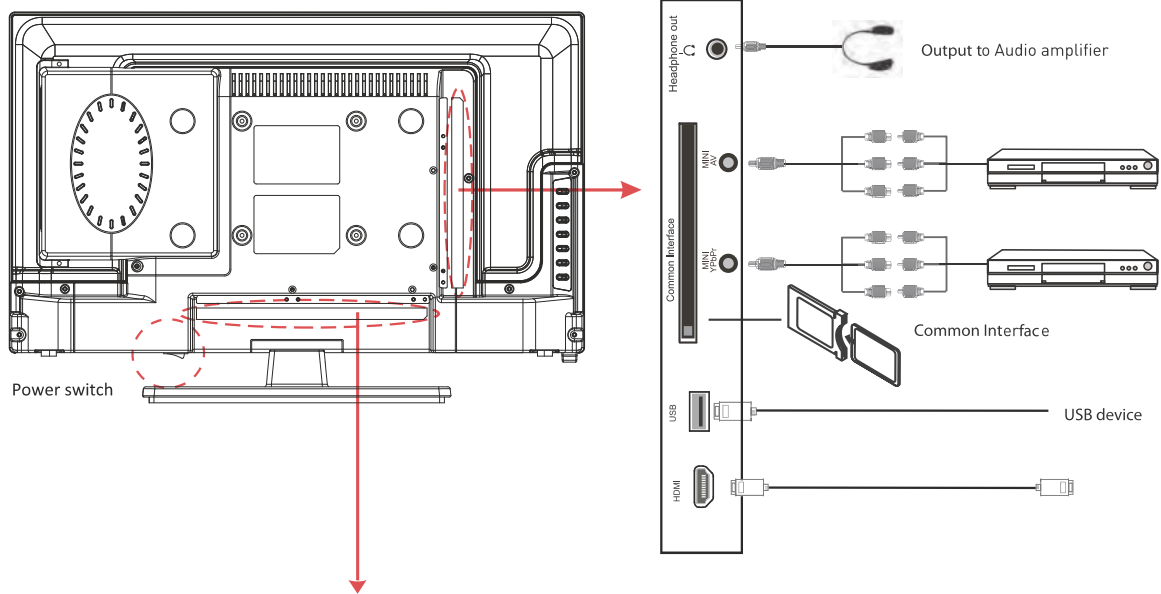

Connecting external devices (continued)

CONNECTIONS

Name	Function Description
POWER	Connect to power supply
HDMI	Connect to the HDMI output of your DVD or Satellite Box
SAT LNB Connection	Connect to Satellite signal
VGA (PC IN)	Connect to the PC VGA output to display PC graphics
PC-IN	PC Audio input
Mini YpbPr	Connect to the YPbPr output on external devices
AV	Connect to AV output on external devices
RF	Connect to TV signal cable
Head phone	Connect Head phone
CI / CI+	CI slot (Pay as you view card slot)
USB	Media playback

Caution:

Before connecting external devices:

- Makes sure to disconnect the appliances from the power supply in order to avoid any potential damage from occurring.
- Make sure to establish the required connection.
- Make sure that the connectors are properly and correctly attached before connecting the appliances to the power supply.

PC connection

As PCs are sometimes still supplied with a 'conventional' CRT monitor, you may need to adjust the display settings of your PC's graphics card, otherwise the pictures may not appear correctly. Switch on your PC (still with your original monitor connected) now select the screen resolution, and select 60Hz refresh rate. Switch off your PC, then connect it to your TV while both appliances are still switched off.

VGA, HDMI PC Connection

Use a PC-VGA cable (not supplied) to connect the TV to your PC. You can also use an HDMI cable to connect to your PC (if your PC Graphic card supports HDMI). When the HDMI cable is used, the PC audio cable is no longer required. If you use the HDMI to DVI cable, you will need to use the PC audio cable. Connect all cables carefully and do not bend or break the connector pins.

When using the VGA cable

- Switch on the TV
- Switch on the PC
- Select PC/VGA as input source

When using the HDMI cable

- Select HDMI as input source

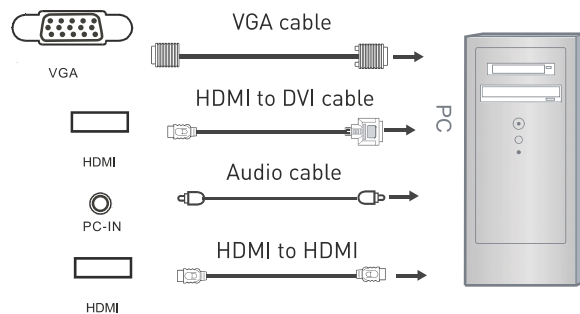

(All illustrated cables are not supplied)

Satellite connection



Connect the DVB-S/DVB-S2 signal to the SATELLITE LNB on the TV SET. Select the SATELLITE input source using the DVBS/DVBS2 button on the remote control.

Note: If there is no DVBS(S2) reception, please check whether there is any problem (such as a short-circuit) on the F-type connector, on the LNB cable, the multi-switch etc. of your satellite antenna system. In this case, please disconnect the TV set from the antenna system. If necessary, consult a qualified technician to solve the problem.

Connecting Video camera and Video recorder

Video camera

- Connect the AV cable to the TV and to the video camera.
- Turn on both video camera and the TV.
- Select AV/CVBS source
- You can now see the playback picture from the video camera. Note:
- To connect the video camera using other cables, refer to the video camera instruction manual.

Video recorder

- Connect the Scart cable to the TV and video recorder.
- Turn on both video recorder and the TV.
- Select Scart source
- You can now see the playback picture from the video recorder.

Note:

To connect the video recorder using other cables, refer to the video recorder instruction manual.

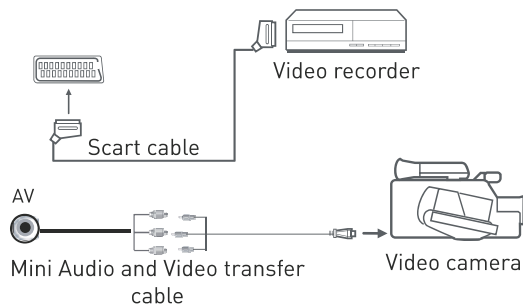

Connecting an audio system

You can supply the TV sound to the stereo system (A) with the Scart socket. Use a special Scart cable SCART to RCA. (Please consult your hi-fi instructions for details). If you have a surround sound amplifier/decoder (B) Use the Scart cable or the special Scart cable Scart to RCA.

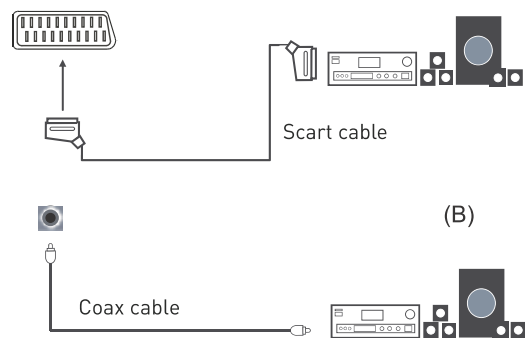
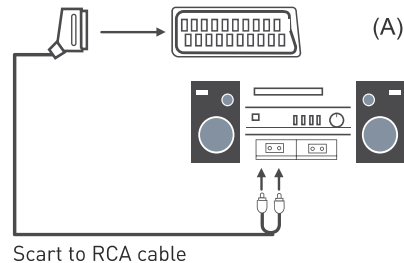

(All illustrated cables are not supplied)

Connecting a Digital Audio Receiver



For better sound quality, you may want to play the audio through your multi-channel audio receiver.

- Use an audiocable to connect the TV's Digital Audio out socket to an external audio receiver's audio optical input socket.
- Plug the connected devices into the mains socket
- Press the STANDBY button on the TV or the button on the remote control
- Press the SOURCE button on the TV or the SOURCE button on the remote control to display the Source List. Use the buttons to select any desired input source and then press the OK button to confirm.

Note: The TV's volume control will have no effect. You may control the audio level via the Audio Receiver.

Connecting a DVD player

Connect a DVD player using either a SCART cable or the HDMI cable. (only if your external equipment supports HDMI).
Select HDMI as input source

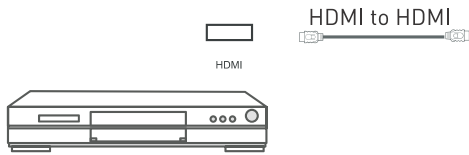

HDMI Connection

TV Back

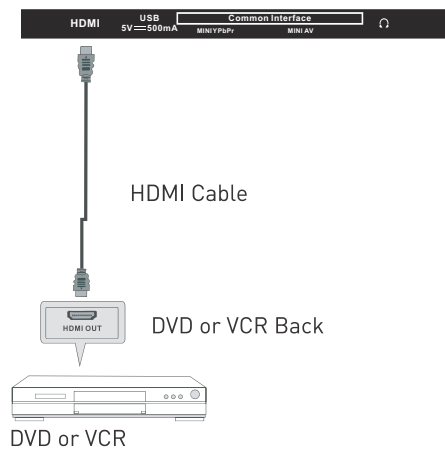

HDMI connection allows the user to transfer all audio/video/control signals through one cable only. These signals are transferred in digital.

USB Connection

Put the USB flash drive in to the USB port, Select the USB channel source using the SOURCE button on the remote control. The maximum supported capacity of external storage devices (e.g. USB memory stick or USB hard disk) is 1TB. However, not all available storage media may be compatible.



AV Connection

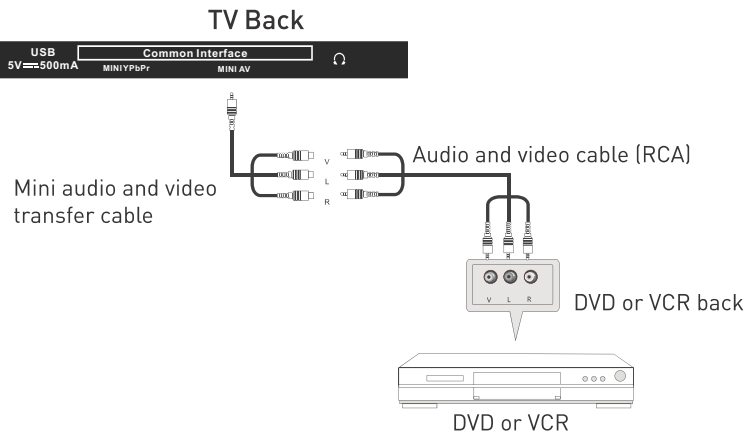

Connect the VIDEO and AUDIO output jack of the DVD or VCR to the VIDEO jacks on the TV set using the YPbPr converter cable(not supplied) and an RCA cable (not supplied). Match the jack colors: Video is yellow, Audio left is white, and Audio right is red. Press the SOURCE button on the remote control and select the AV input source.

YPbPr Connection

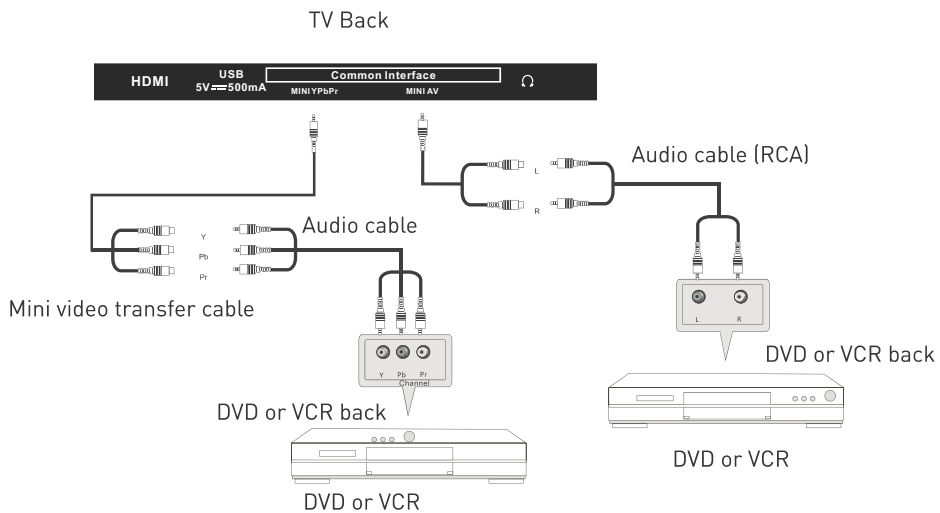

Connect the YPbPr output of the DVD or VCR to the YPbPr input on the TV set Connect the Audio output of the DVD or VCR to the Audio input jacks on the TV set using two RCA cables together with the converter cables(not supplied). Match the jacks colors : Y is green, Pb is blue, Pr is red, Audio left is white, and Audio right is red. Press the SOURCE button on the remote control and select the YPbPr input source.

TV OPERATION AND SYSTEM SETUP

SELECT INPUT SOURCE

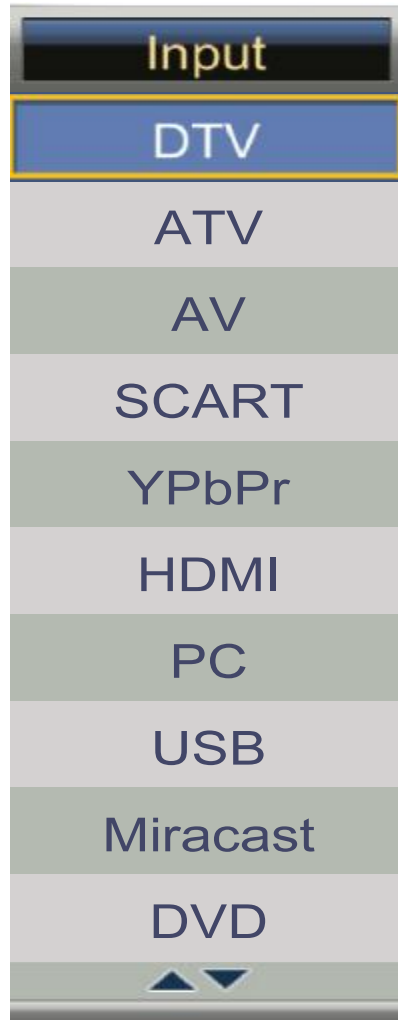

Press **SOURCE** button to display the input source list;
Press **▲/▼** button to select the input source you want to watch;
Press **ENTER** button to enter the input source;



- Press **MENU** button to display the MAIN OSD MENU;
- Press **▲/▼** button to select the MENU you want;
- Press **ENTER** button or **▶** button to enter the sub menu, and press **◀** button to return back to the previous menu.
- Press **▲/▼** button to select the option and then press **ENTER** button or **▶** button to enter the sub-menu, press **◀/▶** button to adjust the value or press **◀/▶** button to select in the sub menu;
- You can press **MENU** button to save and return back to the previous menu, and press **EXIT** button to exit the entire menu.

Picture Menu

The picture is for a reference only; the actual item is the standard.

Press **MENU** button to display the main menu.

Press **▲/▼** button to select Picture in the main menu, and then press **ENTER** button to enter.



1. Press **▲/▼** button to select the option that you want to adjust in the Picture menu, and then press **ENTER** button or **▶** button to enter.

-
2. Press ◀/▶ button to adjust or press ▲/▼ button to select. And press **ENTER** button to select the sub menu.
 3. After finishing your adjustment, press **MENU** button to save and return back to the previous menu, and press **EXIT** button to exit the entire menu.

Picture Mode

Press ▲/▼ button to select Picture Mode, then press **ENTER** button to enter and press ▲/▼ button to select.
(Available Picture Mode: User, Dynamic, Standard, Mild)
You only can change the value of brightness, contrast, sharpness, color, when the picture is in User mode.

TIPS: You can press **P-MODE** button on the remoter control again and again to change the picture mode directly.



Brightness

Press ▲/▼ button to select **Brightness**, then press **ENTER** button to enter and press ◀/▶ button to adjust. Then press **MENU** button to return back the previous menu directly.

Contrast

Press ▲/▼ button to select **Contrast**, then press **ENTER** button to enter and press ◀/▶ button to adjust. Then press **MENU** button to return back the previous menu directly.

Sharpness

Press ▲/▼ button to select **Sharpness**, then press **ENTER** button to enter and press ◀/▶ button to adjust. Then press **MENU** button to return back the previous menu directly.

Colour

Press ▲/▼ button to select **Colour**, then press **ENTER** button to enter and press ◀/▶ button to adjust. Then press **MENU** button to return back the previous menu directly.

Tint

Press ▲/▼ button to select **Tint**, then press **ENTER** button to enter and press ◀/▶ button to adjust. Then press **MENU** button to return back the previous menu directly.

Colour Temperature

Press ▲/▼ button to select **Colour Temperature**, then press **ENTER** button to enter and ◀/▶ button to select Standard, Cool, Warm.

Aspect Ratio

Press ▲/▼ button to select **Aspect Ratio**, then press **ENTER** button to enter and ◀/▶ button to select Auto,4:3, 16:9,Full,Zoom1,Zoom2,Cinema,Just Scan.

Noise Reduction

Press ▲/▼ button to select **Noise Reduction**, then press **ENTER** button to enter and ◀/▶ button to select Off,Low, Middle,High.

SOUND Menu

The picture is for a reference only; the actual item is the standard.

Press **MENU** button to display the main menu.

Press **▲/▼** button to select Sound in the main menu, and then press **ENTER** button or **▶** button to enter.



1. Press **▲/▼** button to select the option that you want to adjust in the Sound menu, then press **ENTER** button to enter.
2. press **◀/▶** button to adjust or press **▲/▼** to select, and press **ENTER** button to select submenu.
3. After finishing your adjustment, Press **MENU** button to save and return back to the previous menu, or press **EXIT** button to exit the entire menu.

Sound mode

Press **▲/▼** button to select **Sound mode**, and then press **ENTER** button to enter. And then press **◀/▶** button to select. [Available Sound mode: User, Standard, Music, Movie].

You can change the value of bass and treble, Balance and EQ, when the sound is in User mode.

TIPS: You can press **S-MODE** button on the remote control to change the Sound Mode directly.

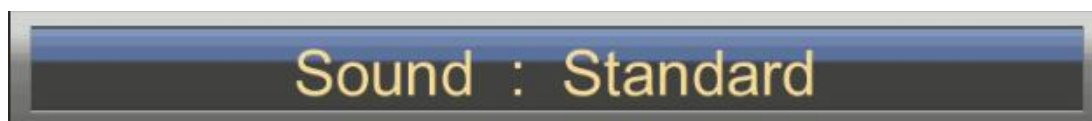

Bass

Press **▲/▼** button to select **Bass**, then press **ENTER** or **▶** button to enter and press **◀/▶** button to adjust. It can only be adjusted under user mode. Then press **MENU** button to return back the previous menu directly.

Treble

Press **▲/▼** button to select **Treble**, then press **ENTER** button to enter and press **◀/▶** button to adjust. It can only be adjusted under user mode. Then press **MENU** button to return back the previous menu directly.

Balance

Press ▲/▼ button to select **Balance**, then press **ENTER** button to enter and press ◀/▶ button to adjust. Then press **MENU** button to return back the previous menu directly.

Surround

Press ▲/▼ button to select **Surround**, and then press **ENTER** button to enter and press ◀/▶ button to select ON or OFF.

AVL

Press ▲/▼ button to select **AVL**, and then press **ENTER** button to enter and press ◀/▶ button to select ON or OFF.

SPDIF

Press ▲/▼ button to select **SPDIF**, and then press **ENTER** button to enter and press ◀/▶ button to select Off,PCM, Auto,Multi.

Audio Description

Press ▲/▼ button to select **Audio Description**, and then press **ENTER** button to enter and press ▶ button to enter the sub-menu.

Channel

The picture is for a reference only; the actual item is the standard.

Press **MENU** button to display the main menu.

Press ▲/▼ button to select **Channel** in the main menu, and then press **ENTER** button to enter.

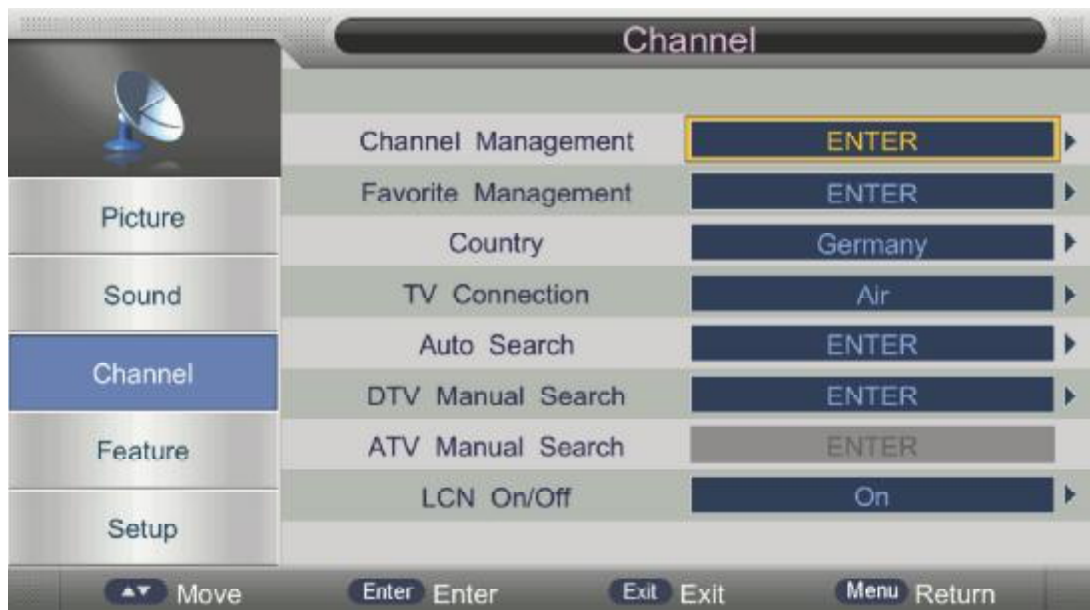

1. Press ▲/▼ button to select the option that you want to adjust in the **APPLICATIONS** menu, and then press **ENTER** button to enter.
2. Press ◀/▶ button to select and press **ENTER** button to select the sub menu.
3. After finishing your adjustment, press **MENU** button to save and return back to the previous menu, or press **EXIT** button to exit the entire menu.

Channel Management

Press ▲/▼ button to select **Channel Management**, and then press **ENTER** button to rename the channel selected. The menu will appear as follows:



Key Description:

CH button: Press CH+ or CH- to turn the page.

RED button: Press this button to delete the channel selected.

GREEN button: Press this button to lock the channel.

YELLOW button: Press this button to skip the channel.

BLUE button: Press this button to move the channel.

Favorite Management

Press ▲/▼ button to select **Favorite Management**, and then press **ENTER** button to the Favorite Management menu. The menu will appear as follows:



Key Description:

RED button: Press this button to set the favorite channel to "Favorite 1".

GREEN button: Press this button to set the favorite channel to "Favorite 2".

YELLOW button: Press this button to set the favorite channel to "Favorite 3".

BLUE button: Press this button to set the favorite channel to "Favorite 4".

TV Connection

Press **▲/▼** button to select **TV Connection**, and then press **ENTER** button to select which the TV connect type you use.

Auto Tuning

Press **▲/▼** button to select **Auto Tuning**, and then press **ENTER** button to enter (When the System Lock is on, please input the PIN code to unlock).



DTV Manual Search

Press **▲/▼** button to select **DTV Manual Search**, and then press **ENTER** button to start the scan. (When the System Lock is on, please input the PIN code to unlock).



ATV Manual Search

Press ▲/▼ button to select **ATV Manual Search**, and then press **ENTER** button to start the scan the ATV channels.

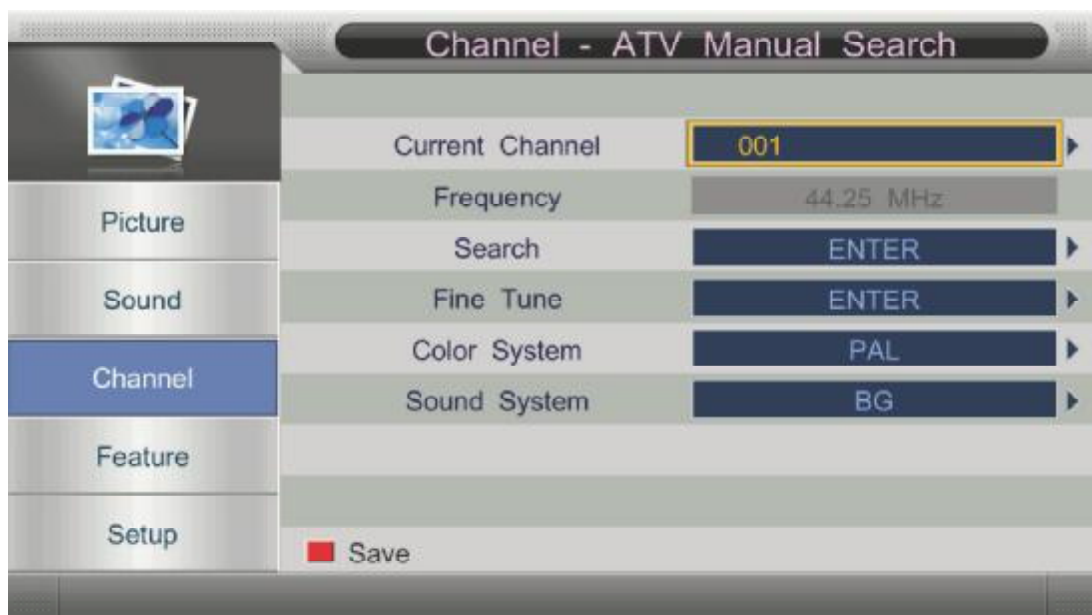

LCN On/Off

Press ▲/▼ button to select **LCN On/Off**, and then press **ENTER** button to set LCN to on or off.

EPG

Press **EPG** button to open **EPG** menu, and then press **GREEN** button to set a timer.
Press **RED** button to switch daily mode and weekly mode.

Press **YELLOW** button to switch to previous day.
 Press **BLUE** button to switch to next day.

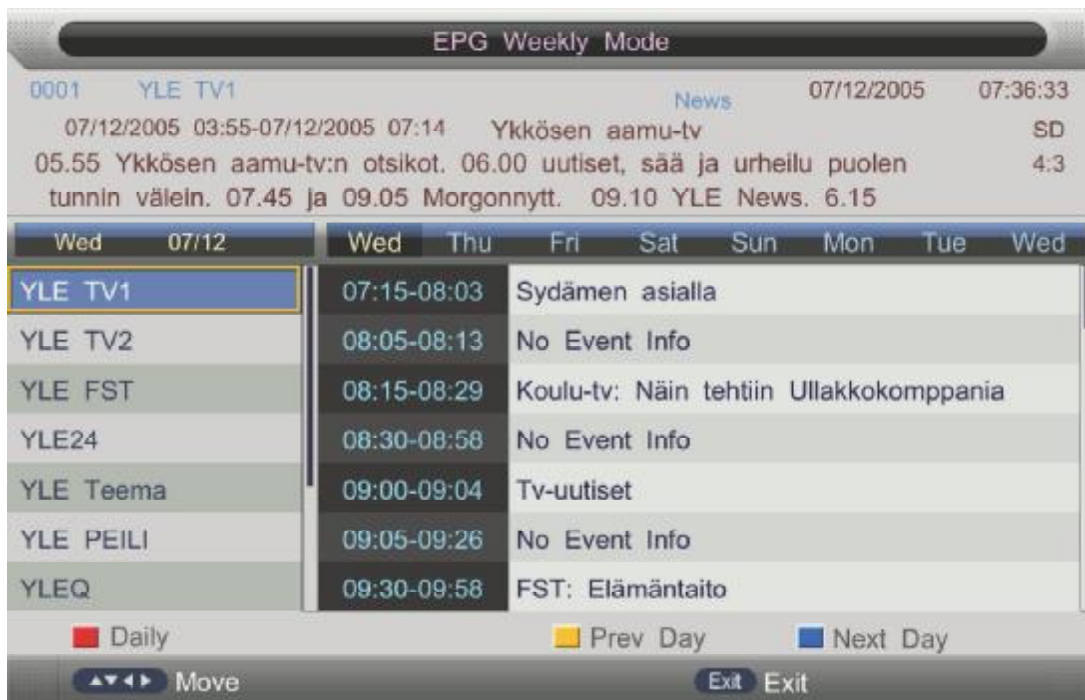

Feature

The picture is for a reference only; the actual item is the standard.

Press **MENU** button to display the main menu.

Press **▲/▼** button to select **Feature** in the main menu, and then press **ENTER** or **▶** to enter.



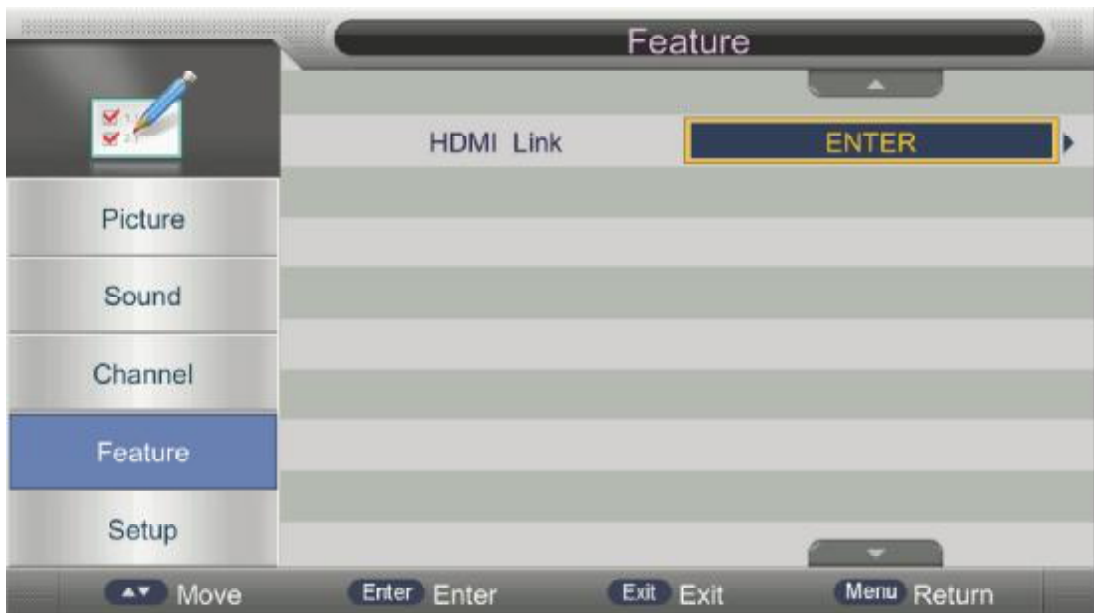

1. Press ▲/▼ button to select the option that you want to adjust in the **Feature** menu, then press **ENTER** to enter.
2. Press ◀/▶ button to adjust or press ▲/▼ button to select.
3. After finishing your adjustment, press **MENU** button to save and return back to the previous menu and press **EXIT** button to exit the entire menu.

Lock

Press ▲/▼ button to select **Lock**, then press **ENTER** button to enter the sub menu with the password "0000":

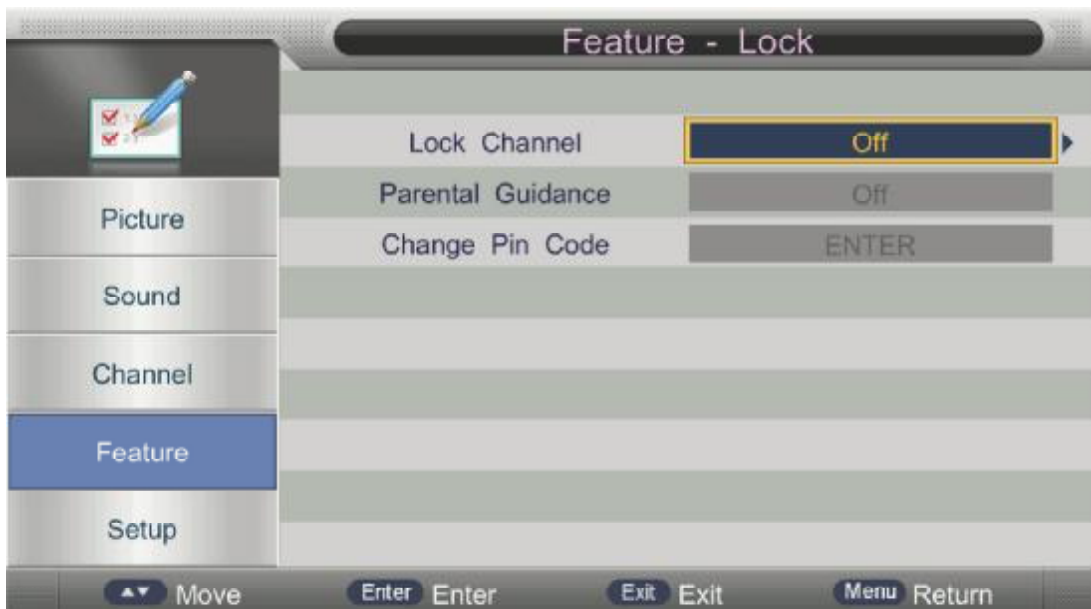

Lock Channel

Press ▲/▼ button to select **Lock Channel**, then press **ENTER** or ► button to select ON or OFF.

Parental Guidance

Press ▲/▼ button to select **Parental Guidance**, then press **ENTER** or ► button to enter the sub menu. Then press ▲/▼ button to select Rate (From 4-17, or None). Then press **ENTER** or ► button to confirm.

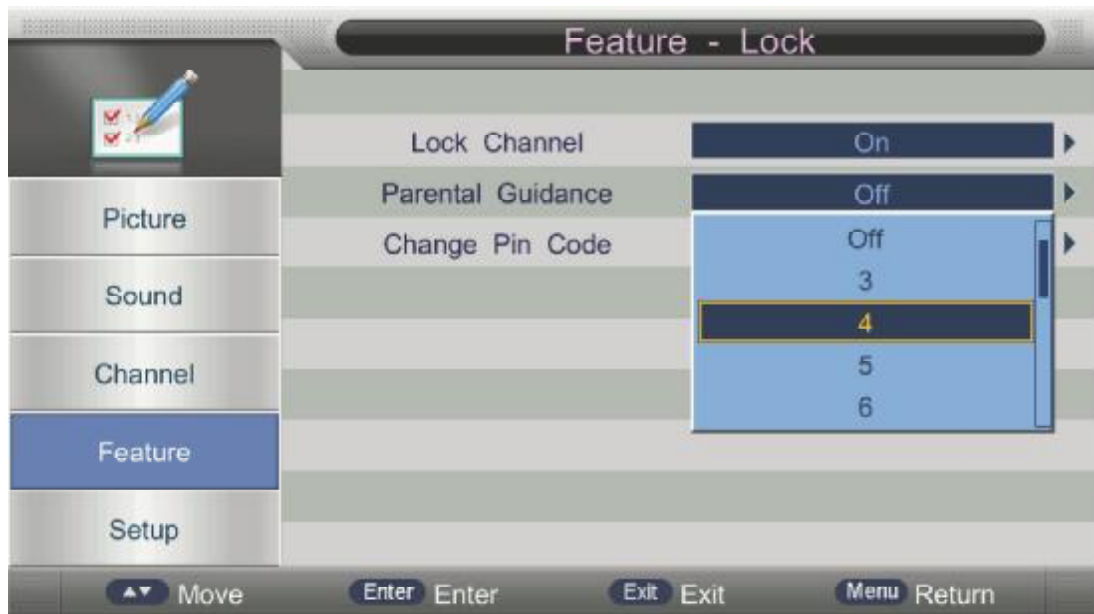

Change Pin Code

Press ▲/▼ button to select **Change Pin Code**, then press **ENTER** to enter and Change Pin Code menu will appear as follows:



Input old password at "Old Password", (if the old password is incorrect, the password will not be allowed to modify.)
Input new password at "New Password".
Input new password again at "Confirm New Password", if new password and confirm new password consistent, the successfully updated menu will appear a few second, otherwise, the menu will display the password mismatch.

Language

Press ▲/▼ button to select **Language**, then press **ENTER** or ► button to enter the sub menu, then press ▲/▼ button to select, then press **ENTER** or ► button to confirm.

Sleep Timer

Press ▲/▼ button to select **Sleep Timer**, then press **ENTER** button to enter and press ▲/▼ button to select off, 10mins,20mins,30mins,60mins,90mins,120mins,180mins,240mins.

Auto Power Off

Press ▲/▼ button to select **Auto Power Off**, then press **ENTER** to enter the sub menu, Then Press ▲/▼ to select off, 1 hour,2 hours,4 hours then press **ENTER** to confirm. (When the PC signal is connected).

Hearing Impaired

Press ▲/▼ button to select **Hearing Impaired**, then press **ENTER** button to enter and press ▲/▼ button to select off or on.

CI Info

Press ▲/▼ button to select **CI info**, then press **ENTER** button to display the CI slot Information.

PVR/TimeShift

Press ▲/▼ button to select **PVR/TimeShift**, then press **ENTER** button to open the sub-menu. As follows:

1. Press ▲/▼ button to select the option that you want to adjust in the **PVR/TimeShift** menu, then press **ENTER** or ► button to enter.
2. After finishing your adjustment, press **MENU** button to save and return back to the previous menu and press **EXIT** button to exit the entire menu.

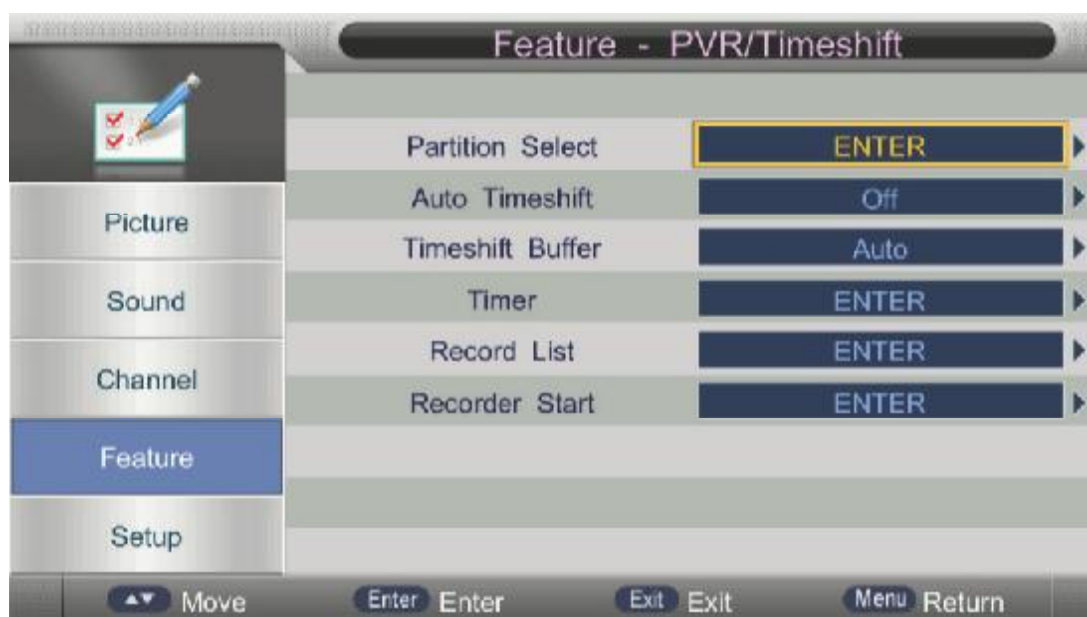

Partition Select

Press ▲/▼ button to select **Partition Select**, then press **ENTER** button to open the sub-menu. As follows:



Press ▲/▼ button to select different disk on in Partition Select menu.

Press **RED** button to format the disk you selected.

Press **GREEN** button to set the disk you selected to default partition.

Auto TimeShift

Press ▲/▼ button to select **Auto TimeShift**, Press **Enter** or ► button to open the sub-menu then Press ▲/▼ to select on/off.

TimeShift Buffer

Press ▲/▼ button to select **TimeShift Buffer**, Press **Enter** or ► button to open the sub-menu then Press ▲/▼ to select Auto, 30 Mins, 1hr, 2hr.

Timer

Press ▲/▼ button to select **Timer**, Press **Enter** or ► button to open the sub-menu.

Note: you can also open Timer menu by key **REC.TASK**

Press ▲/▼ button to select **Timer**, and then press **ENTER** button to display the sub menu, and then press **YELLOW** button to set an appointment record. As follower:



Press number keys and direction keys, user can set the channel, date, start time, mode, type and record length information on this menu.

When approaching the preset time, the screen will be appear a countdown to remind the user menu.

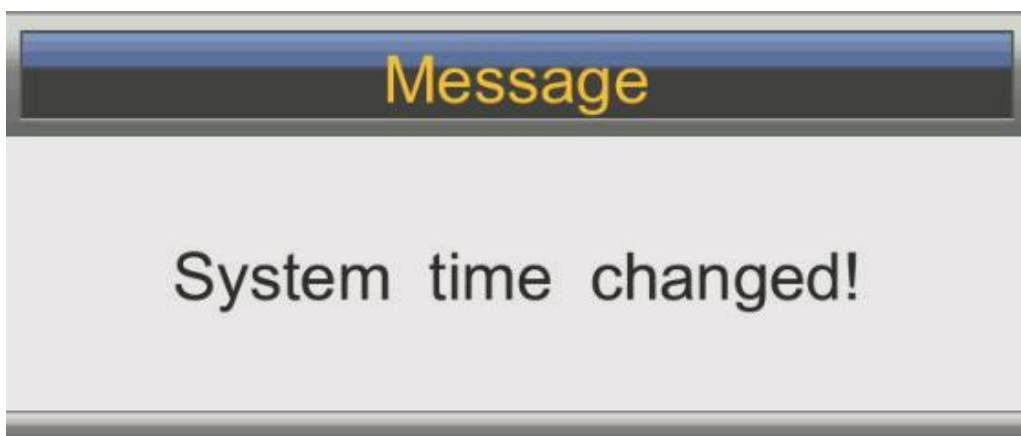

Record List

Press ▲/▼ button to select **Record List**, Press **Enter** or ► button to open the sub-menu.

Note: you can also open Timer menu by key **REC.File**

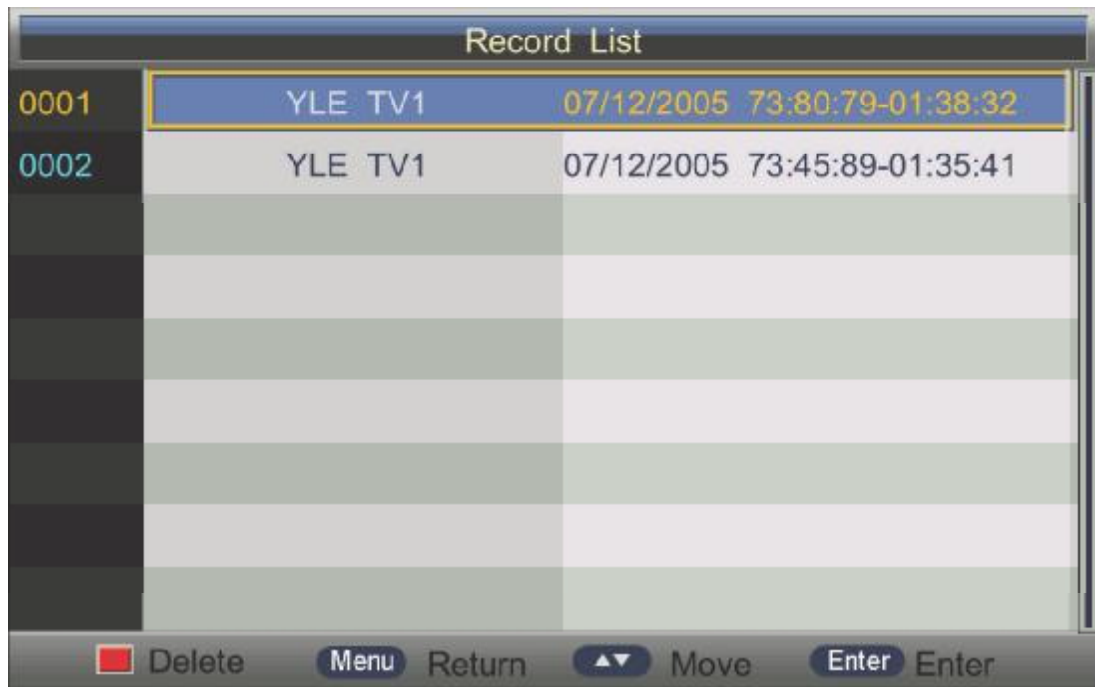

Press ▲/▼ to select record program file(.ts file).
 Press **ENTER** to play.
 Press red button to delete the selected file.
 If press **ENTER** to play, the menu will appear as follows:



Recorder Start

Press ▲/▼ button to select **Recorder Start**, Press **Enter** or ► button to enter directly record .
 Note: you can also open Timer menu by key ●

HDMI Link

Press ▲/▼ button to select **HDMI Link**, Press **Enter** or ► button to enter sub-menu .



Enable HDMI Link

Press ▲/▼ button to select **Enable HDMI Link** ,Press **Enter** or ► button to select on/off.
If you want to set the item in HDMI Link menu,you must set Enable HDMI link to on.

Auto PowerOn

Press ▲/▼ button to select **Auto PowerOn** ,Press **Enter** or ► button to select on/off.

Auto Standby

Press ▲/▼ button to select **Auto Standby** ,Press **Enter** or ► button to select on/off.

Speaker Preference

Press ▲/▼ button to select **Speaker Preference** ,Press **Enter** or ► button to select TV Speakers,Amplifier.
Note:This item can only be selected when cec device is detected.

Amplifier Support ARC

Press ▲/▼ button to select **Amplifier Support ARC** ,Press **Enter** or ► button to select on/off.
Note:This item can only be selected when Amplifier device is detected.

Setup

The picture is for a reference only; the actual item is the standard.

Press **MENU** button to display the main menu.

Press ▲/▼ button to select **Setup** in the main menu, then press **ENTER** to enter.



1. Press ▲/▼ button to select the option that you want to adjust in the **Setup** menu, then press **ENTER** or ► button to enter.
2. Press ◀/▶ button to adjust or press ▲/▼ button to select.
3. After finishing your adjustment, press **MENU** button to save and return back to the previous menu and press **EXIT** button to exit the entire menu.

OSD Timer

Press ▲/▼ button to select **OSD Timer**, and then Press **ENTER** or ► button to select. (Available OSD Timer: 5S,10 S, 15S,20S, 25S,30S, never), then press **ENTER** button to confirm.

Auto Scart

Press ▲/▼ button to select **Auto Scart**, and then Press **ENTER** or ► button to select on or off .

PC Setup

Press ▲/▼ button to select **PC Setup**, then press **ENTER** or ► to enter sub-menu.

Blue Screen

Press ▲/▼ button to select **Blue Screen**, and then Press **ENTER** or ► button to select on or off.

Home Mode

Press ▲/▼ button to select **Home Mode**, and then Press ◀/▶ button to select Home or Store, then press **ENTER** button to confirm.

Reset TV Setting

Press ▲/▼ button to select **Reset TV Setting**, and then Press **ENTER** button to enter the sub menu, enter the password if locked, and then you can quickly make some basic settings of the TV. As follows:

Language

User can press ▲/▼ button to select the language.

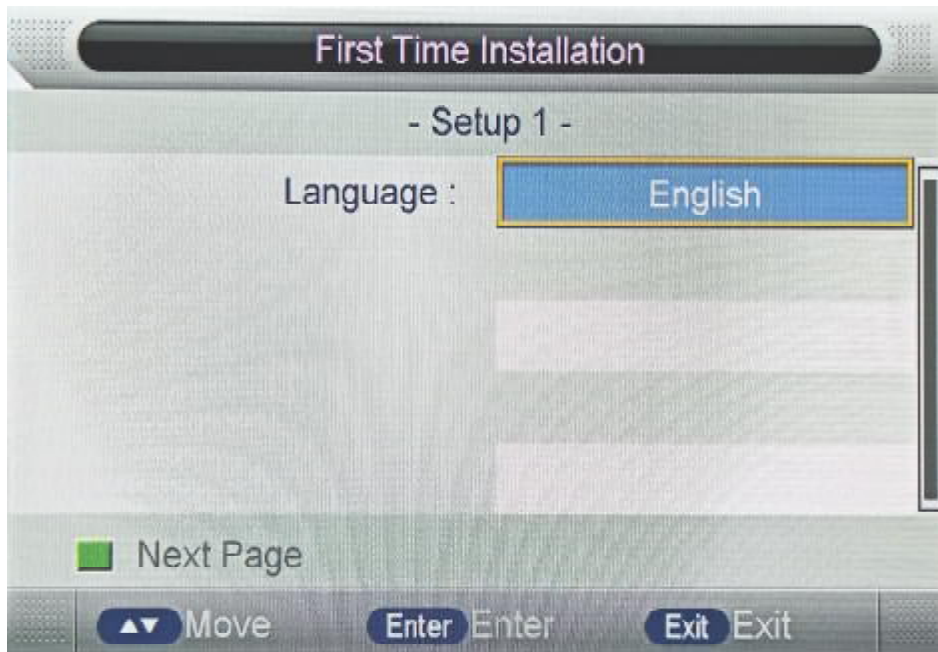

And then press **ENTER** to enter the next step page.

Country

User can press ▲/▼ button to select the country.



And then press **ENTER** to enter the next step page.

Home Mode

User can press ▲/▼ button to select the home mode of television programs.

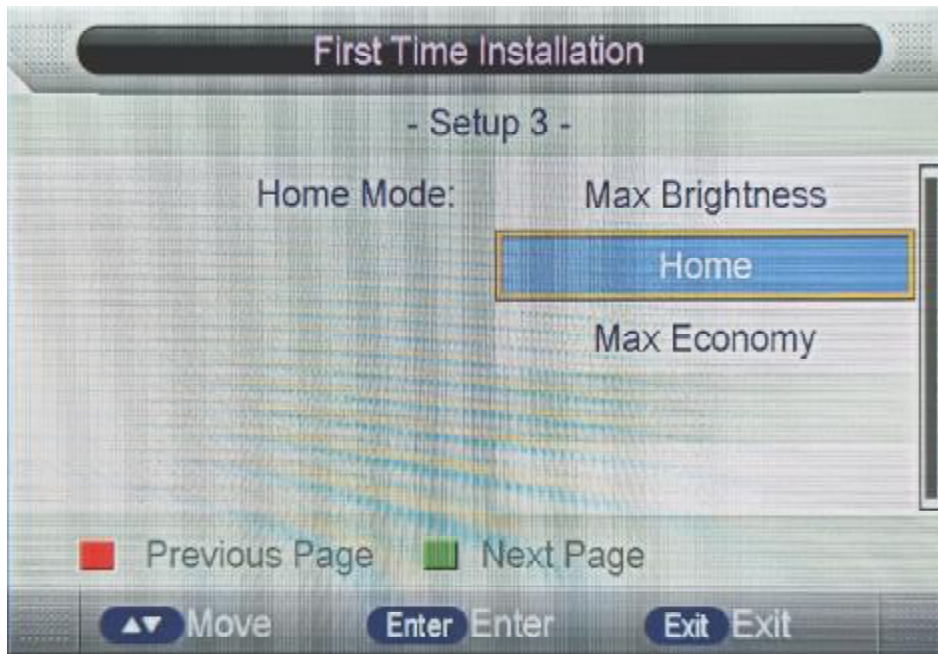

And then press **ENTER** to enter the next step page.

Auto Power Of

User can press ▲/▼ button to select the Auto power off time: off,1Hour,2Hours,4Hours.

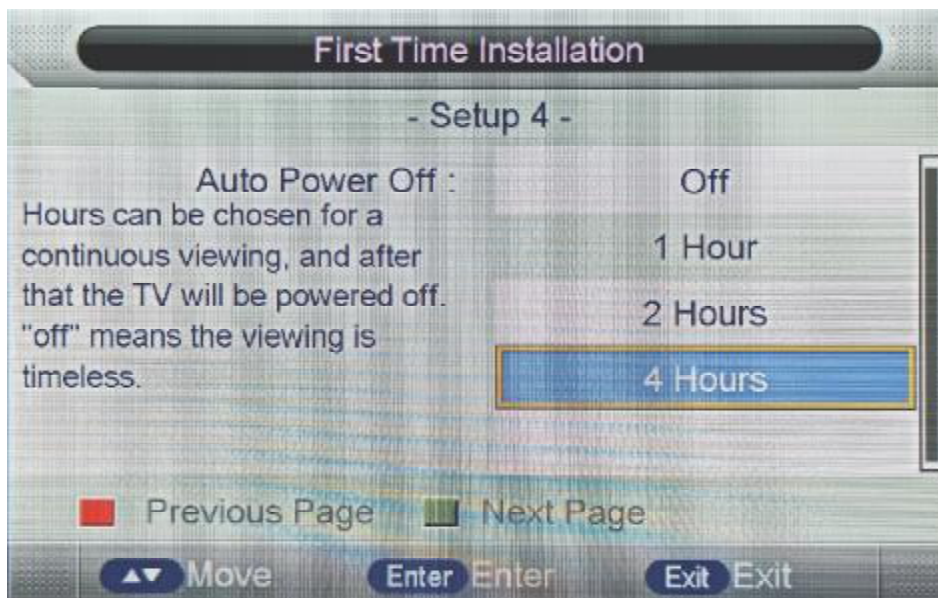

And then press **ENTER** to enter the next step page.

TV Connection

Press ▲/▼ button to select the item of TV Connection.

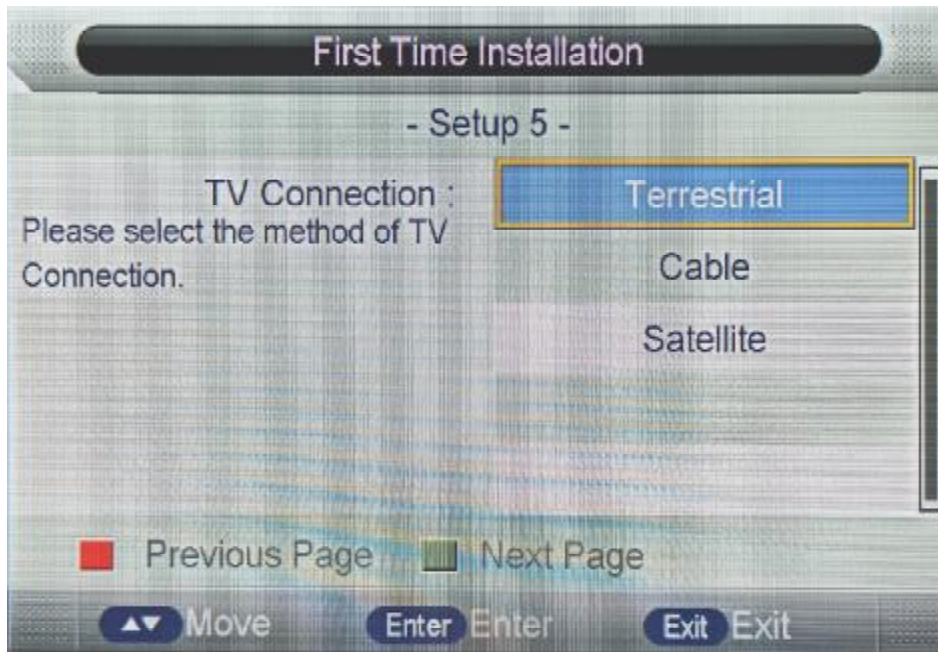

And then press **ENTER** to enter the next step page.

Auto Search

Press ▲/▼ button to select the turning mode, and then press ◀/▶ button to enter auto search process.

User can press **MENU** button to skip the scan and press **EXIT** button to exit the scan



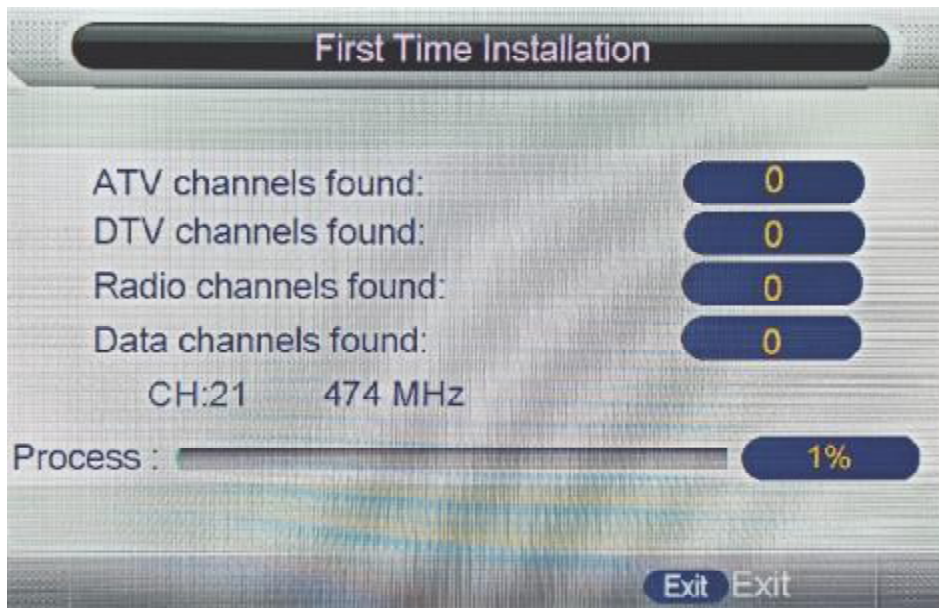

Version

Press ▲/▼ button to select **Version**, and then press **ENTER** to enter the sub menu, you can check the software version this TV.

How to user Record

The HK-T.S2512C support two type to record :

- A、 Direct Record
- B、 Subscribe Record

Direct Record.

1. In the DTV source, you can start record function by press the "REC" key while program playing. Before that, you have to make sure the USB storage device is inserted and the device checking and Initialization is done.

If you press "REC" key when there's no USB storage device inserted, the prompt window will appear as follow.

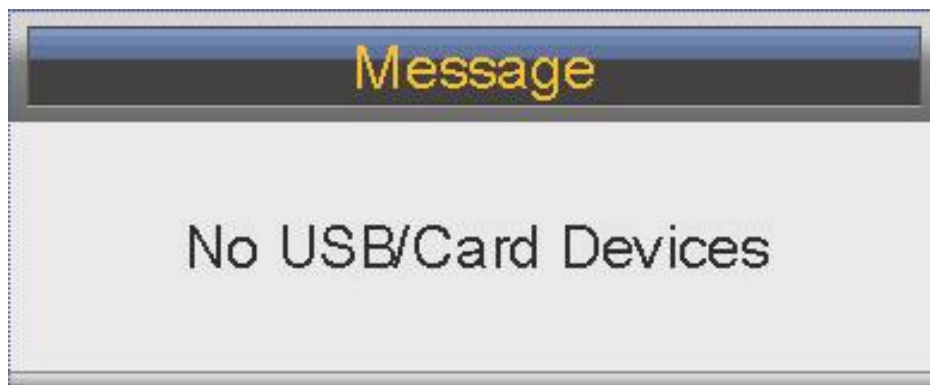

If you press "REC" key during the device checking and Initialization, the prompt window will show black screen about 2s. when the TV is recording, it will appear the recording menu.



2. After record started, you can press the button of PLAY/PAUSE on the RC to set the play mode. You can see the detail info by the record menu.



3. Press the ● Button on the remote to set rec duration time when rec is running. As follows:



4. You can press "STOP" key to stop record function after confirm.



Note: Time shift function will stop when there's no space left on the USB storage device.

Subscribe Record

1. In the DTV source, you can enter the Timer menu set the Subscribe Record. Press the **YELLOW** button to add the record task.

The Way: Main menu--->Feature--->PVR/TimeShift--->Timer

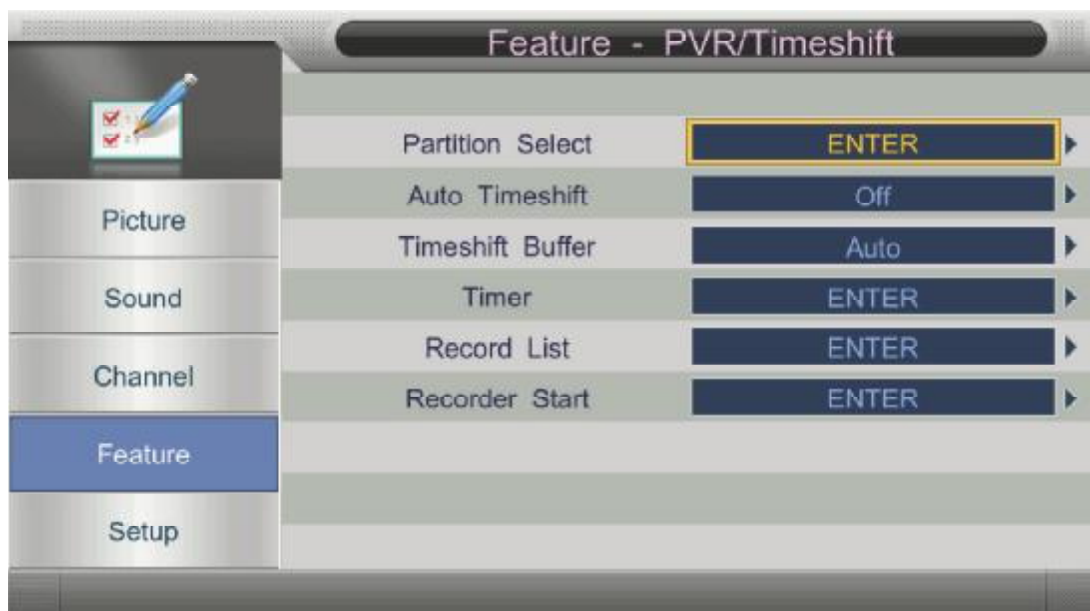



2. If you enter the Timer Edit menu, you can set the record task that you want to record.

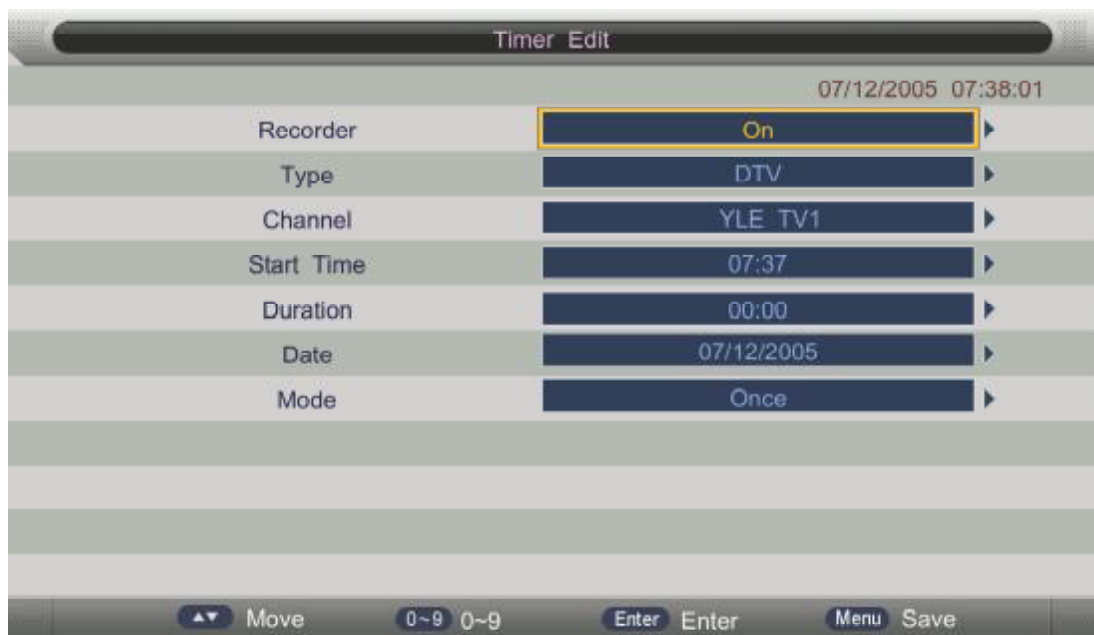

3. When you success to set the record task, if the TV is standby mode, it will auto power on when one minutes before the start of the task.
4. When the record task time is start, It will auto record, but you must check you USB storage device inserted and it is enough speed to record. Otherwise the task will failure.
5. The TV enter false standby mode when the task is start, you can press the **POWER** button to watch the TV program. You can do same operation as Direct Record. When you press POWER again, if the task is not over, the TV will power off the panel and continue to record. The TV will real power off until the record task is over.
6. When you press the REC.TASK button, you can enter the timer menu too.

How to user Time shift

1. In the DTV source,you can start timeshift function by press the **T.SHIFT** button while program playing. Before that, you have to make sure the USB storage device is inserted and the device checking and Initialization is done.

If you press **T.SHIFT** button when there's no USB storage device inserted, the prompt window will appear as follow.



If you press **T.SHIFT** button during the device checking and Initialization, the prompt window will appear as follow.



2. After record started, you can press the button of PLAY/PAUSE to set play mode,and you can seen the detail info by the time shift menu.





3. You can press **STOP** button to jump to the real time broadcast of the program, and press **STOP** key again to stop time shift function after confirm.



Hotel Mode

1. How to enter and exit the hotel mode menu:

- Enter: You can enter the hotel mode menu by the follow steps:
- Press password "4588" under the source menu.
- Select: Use direction key to select the different items.
confirm: Press the key "ENTER" or right direction key to confirm.



2. Function description of hotel mode:

Name	Value	Description	Note
Hotel Lock	On/Off	Open or close hotem mode, set to off by default.	If want to adjust the items in Hotel Menu,you must set this item to “ON”
Channel Lock	On/Off	Lock the channel menu.	If set to ON,user can not enter the channel menu and can not search channel.
Picture Lock	On/Off	Lock the picture menu	If set to ON,user can not enter the picture menu and can not adjust the picture mode,contrast,brightness, and so on.
Sound Lock	On/Off	Lock the sound menu	If set to on ,user can not enter the sound menu,and can not adjust the item likes sound mode,balance,and so on.
Feature Lock	On/Off	Lock the feature menu	If set to on, user can not enter the feature menu.
Setup Lock	On/Off	Lock the setup menu	If set to on, user can not enter setup menu,and change the system settings.
Source Lock		Lock the input source.	Press key“enter” to enter the submenu.If set one

			source lock to "ON", user can not enter that source.
Set Source	Off/ATV/A V...	The default source when power on to enter.	If select a source except the "Off",the tv will enter that source when power on every time
Channel Number	On/Off	The default ATV channel to enter when power on.	
Max Volume	0/./100	The max volume for user to adjust	If change this value ,user can not set the volume out of this limitation.
Default Volume	0/./max volume	The default system volume when power on	The Default Volume can not out of the limit of Max volume.
Next Page		Turn to next page	
Clear lock		Reset the hotel mode	
DataBase Export		Export the channel data.	
DataBase Import		Import the channel data.	
Previous page		Turn to previous page	

MEDIA OPERATION

The picture is for a reference only; the actual item is the standard.

Note: Before operation **MEDIA** menu, Plug in USB device or memory card, then press **SOURCE** button to set the Source to Media.

Press **▲/▼** button to select **MEDIA** in the **Source Menu**, and then press **ENTER** to enter.

You can also enter the Media by pressing **MEDIA** button on the remote control.

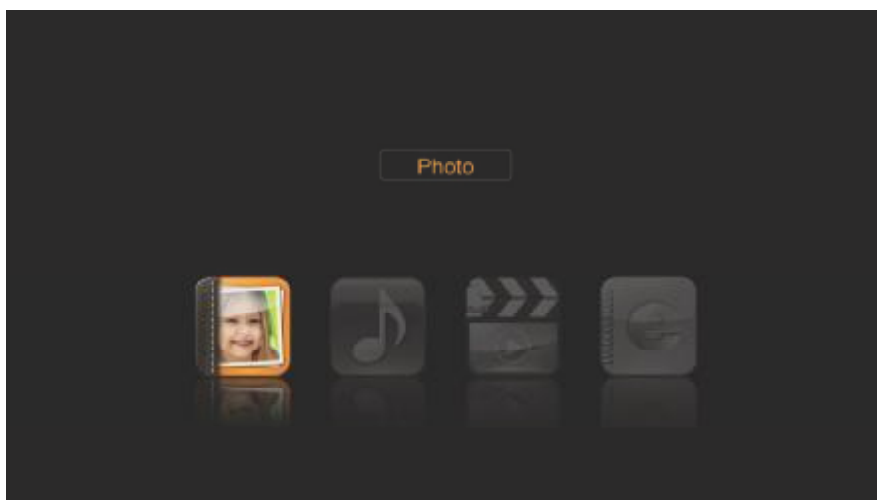

1. Press ◀/▶ button to select the option that you want to adjust in the **Media** menu, then press **ENTER** or ▶ button to enter.
2. Press ◀/▶ button to adjust or press ▲/▼ button to select.
3. After finishing your adjustment, press **MENU** button to save and return back to the previous menu and press **EXIT** button to exit the entire menu.

Photo

The picture is for a reference only; the actual item is the standard.

Press ◀/▶ button to select Photo in the main menu, and then press **ENTER** button to enter.

Press **EXIT** button to return back to the previous menu.



Press ▲/▼ to select the photos, press **ENTER** or ▶| button to view.

Press **RED** button to delete the photo you selected.

Press **GREEN** button to add all photos to play list.



You can see the information of the current playing photo after press **INFO** button, then press **▶||** button to play or pause, you can see the playing state in the right.
Then press **▲/▼** or **◀/▶** button to rotate the picture without control bar.



Notes: Other menu and description are the same as that for Movie menu.

Music

The picture is for a reference only; the actual item is the standard.

Press **◀/▶** button to select **Music** in the main menu, and then press **ENTER** button to enter.

Press **EXIT** button to return back to the previous menu.

Press **RED** button to delete the song you selected.

Press **GREEN** button to add all music to play list.

Press **▲/▼** button to select the song you want to listen, and then press **ENTER** or **▶||** or **▶** button to play.

Press **◀** button to return back to the previous menu.



You can see the information of the current playing song at the left of the menu.

Movie

The picture is for a reference only; the actual item is the standard.

Press ◀/▶ button to select **Movie** in the main menu, then press **ENTER** button to enter.

Press **EXIT** button to return back to the previous menu.



Press ▲/▼ button to select the folder that you want to view.

Press **ENTER** button to select the sub folder.

Press **RED** button to delete the movie you selected.

Press **GREEN** button to add all movies to play list.

Press **ENTER** button or ▶|| button to play,

Press ■ button or **EXIT** button to stop playing.

Press the  button to return back to previous page.

You can see the information of the current playing media at the first few second or after press **INFO** button.

e-Book

The picture is for a reference only; the actual item is the standard.

Press ◀/▶ button to select **e-Book** in the main menu, then press **ENTER** button to enter.

Press **EXIT** button to return back to the previous menu.

Press **Blue** button to open play list.

Press **Enter** button to open quick menu.

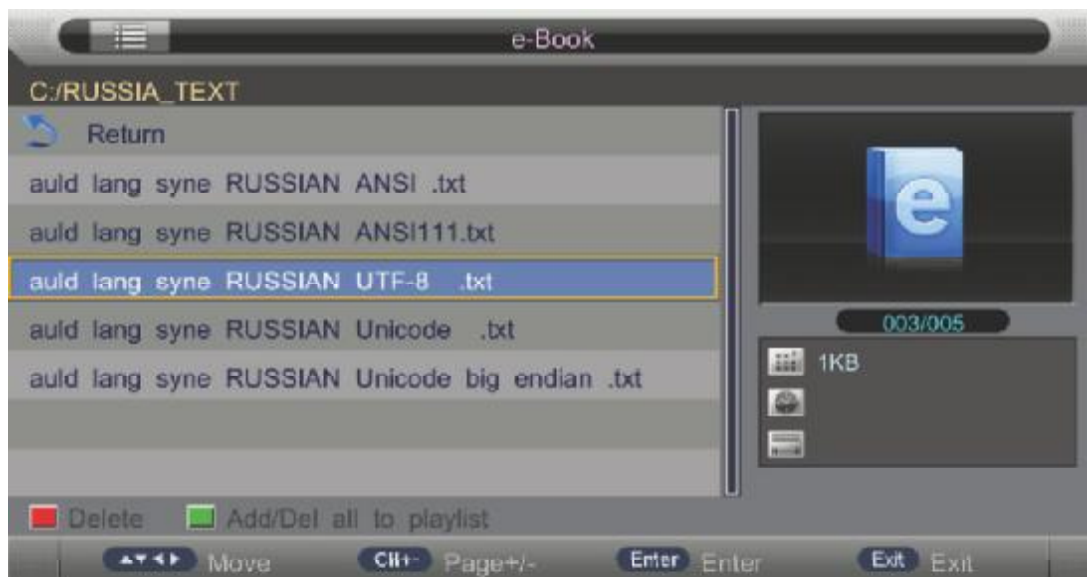

Press ▲/▼ button to select the file you want to view.
 Press **ENTER** button to select the sub folder for file.
 Press **RED** button to delete the text file you selected.
 Press **GREEN** button to add all text files to play list.
 Press **ENTER** button or ► button to play,
 Press ■ button or **EXIT** button to stop playing.

Press the  button to return back to previous page.
 You can see the information of the current playing media at the first few second or after press **INFO** button.

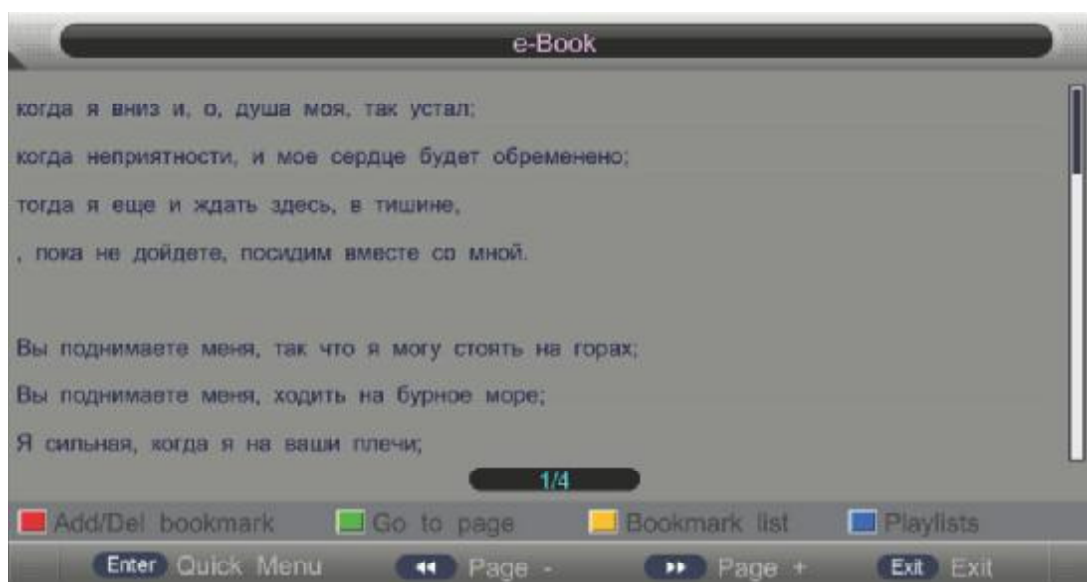

Press **RED** button to add/delete bookmark in current page.
 Press **GREEN** button to jump to special page.
 Press **Yellow** button to open bookmark list.

How to use Miracast to mirror from mobile to TV

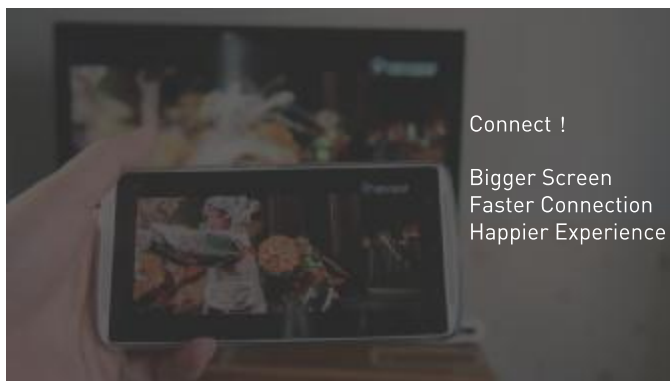
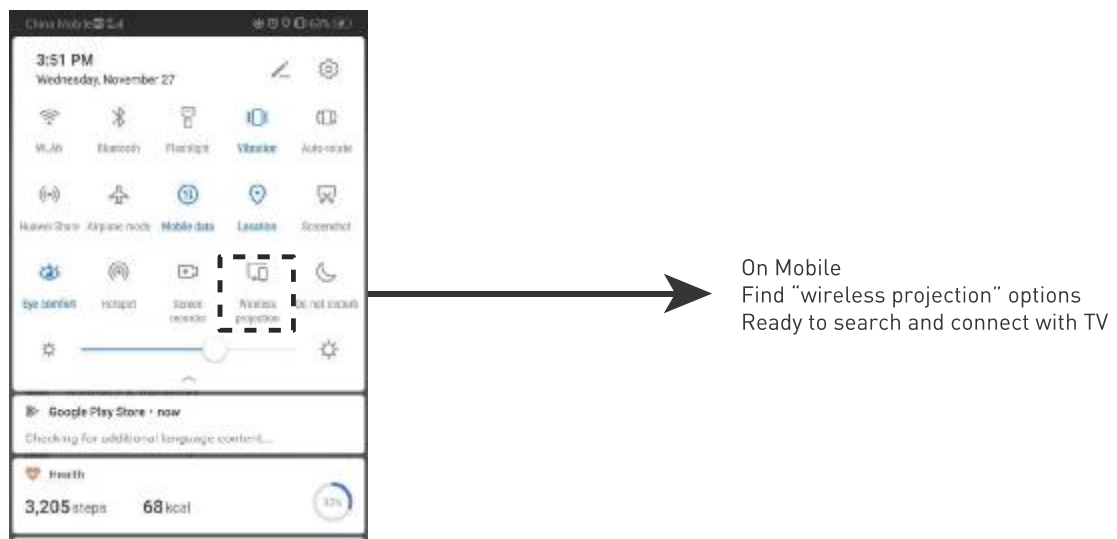
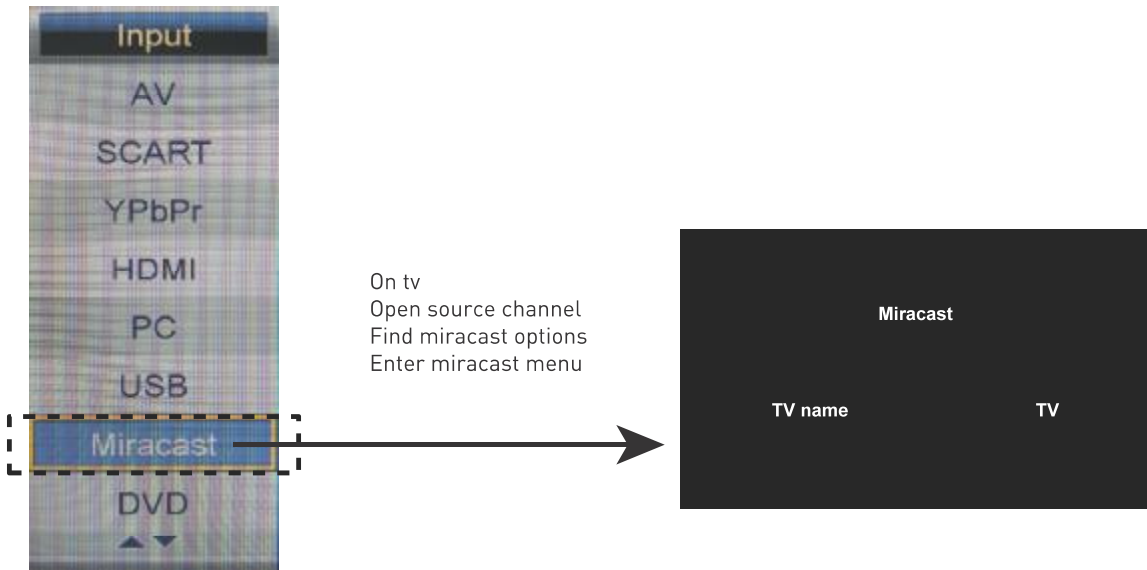

DVD Operation

Basic Operation

Press the Power button on the TV or the remote control, and select "DVD" source by the TV/AV(SOURCE). If there is no disc in the DVD player the screen will show "NO DISC". Insert Disc according to picture next to disc slot. Do not touch the playing surface. Hold the disc around the outside with your fingers and place the disc into the slot The player will automatically draw the disc into the player To "Eject" the disc, press the EJECT button on the TV or the "▲" button on the remote control.

DVD Setup MENU

- DVD Setup is a menu to enable the user to configure the DVD settings.

Enter the DVD Setup menu

Press the Menu button on the remote control and select the OPTIONS MENU. Scroll down and select DVD Setup. When in the DVD setup menu use the ◀▶ button to navigate along the top of the menu and the ▲▼ to scroll up and down the menus.

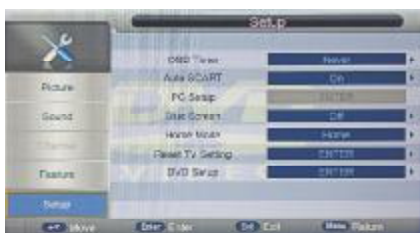

Exit the DVD Setup menu

In the General setup page options scroll down to Exit setup and press OK.

General Setup

TV Display

4:3 Pan Scan

This is selected when the DVD player is connected to a normal TV. Wide-screen images are shown on the screen, but with some parts cut automatically.

4:3 Letter Box

This is selected when the player is connected to a normal TV. Wide-screen images are shown on the screen, with black belt on the top and bottom.

Wide

This is selected when the player is connected to a wide-screen TV.



OSD Language

This is used to select the OSD language



Screen Saver

Start the screen saver, the screen saver image will appear when the player stops or the picture is paused for a few minutes. This saver can keep the screen from being damaged.

- On (Start the screen saver)
- Off (Turn off the screen saver)



Last Memory

This is setting enables you to watch the DVD from the last point it was turned off, (for example changing the source to watch TV)

- ON (Activate the last memory function)
- OFF (Deactivate the last memory function)



AUDIO Setup

• Speaker Setup

Enter the Audio setup page using \blacktriangledown button, press ok see the options.



Downmix

• LT/RT

A disc recorded multi channel soundtrack, the output signal will be incorporated to left and right channel.

• Stereo

A disc recorded multi channel soundtrack, The output signal will be incorporated to stereo.



Dolby Digital Setup

Dynamic

This option is used to set the compression ratio in order to control the sound (Volume) contrast.



Preference Setup



This menu is only available when in DVD mode and no DVD is playing or the DVD has been stopped.

TV Type

PAL

This is selected when the player is connected to a PAL system TV.

MULTI

The player will set the TV system according to the disc in the tray.

NTSC

This is selected when the player is connected to a NTSC system TV.

Audio

Choose the language you want to watch your DVD in. Only if the language is recorded to the DVD will this option be functional.



Subtitle

Choose the subtitle language you want to watch. Only if subtitles have been recorded to the DVD will this option be functional.

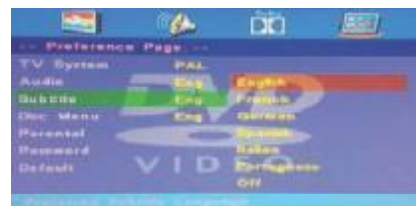

Disc Menu

Choose the language you want to see the Disc menu in. Only if the language is recorded to the DVD will this option be functional.



Parental

Parental lock gives you the option of selecting an age control grade. For example if PG is selected any disc inserted rated higher will not be played.

- KID SAFE
- G
- PG
- PG 13
- PGR
- R
- NC 17
- ADULT



Password

The password is a tool to lock and unlock the parental Lock setting.

Note: (Default password is 123456)



Default

To set the DVD settings back to factory default, choose reset and press the OK button.



Disc Care

About Disc Terms

Title

Generally, pictures or music compressed on a DVD are divided into several sections, "title".

Chapter

The smaller section of picture or music in a DVD under the title, usually one title is comprised of one or more chapters and each of them is numbered for easy searching, but some discs may not have a recording chapter.

Track

A segment of picture or music on a CD, Each track is numbered for searching.

Care of Disc

Video disc contains high-density compressed data that needs proper handling.

1. Hold the disc with fingers by outer edge and/or the center spindle hole. Do not touch the disc's surface.
2. Do not bend or press the disc.



3. Do not expose the disc to direct sunlight or heating sources, Store discs in cabinet vertically and in dry condition.

Prevent exposure to:

Direct sunlight

Heat or exhaust from a heating device

Extreme humidity

Clean the disc surface with a soft, dry cleaning cloth, Wipe the disc surface gently and radially from center toward the outer edge.

Do not apply thinner, alcohol, chemical solvent, or sprays when cleaning. Such cleaning fluids will permanently damage the disc surface.

TROUBLE SHOOTING GUIDE

To assist in locating possible faults use the help guide below.

SYMPTOM	SOLUTION
No Picture	Check that the TV is correctly plugged in. Check that the TV is connected to a suitable power source. Check the electrical supply is turned on.
No Picture	Ensure that the TV is powered on. Check that the cables are fitted securely. Ensure the aerial and/or external sources are connected. Press the SOURCE button to change the source. Turn the TV on or off.
No Sound	Press the MUTE button and check if Mute mode is set. Switch to another channel and see if the same problem occurs. Press V+ button to see if the problem can be solved.
No picture on some channels	Check that correct channel is selected. Adjust the antenna.
No colour on some channels (black & white)	Check if the same problem exists on other channels. Ensure the correct picture settings are selected.
Noisy, Snowy, Ghosting picture.	Check the antenna is connected correctly. Check that the antenna is in good condition. Try moving the antenna.
Will not accept disc	DVD not selected. Select DVD mode with SOURCE button.
Screen shows "NO DISC"	Disc placed incorrectly. Disc must have mirror side facing you if single side.
	Disc damaged or dirty. Inspect disc. If damaged you must discard. If dirty see "Disc care" page.
Picture "Freezes" or breaks up	Disc damaged or dirty, See "Disc care" page
Certain disc functions not working.	Disc may not support required feature. Read disc information.

If none of the suggestions seem to work, try switching your TV off and then on again. If this does not work contact our technical helpline.

NOTE: The TV must only be repaired by a qualified registered service person. Never attempt to remove the back cover as the TV has dangerous voltages inside that may cause fatality or fire.



DVD-Signal: NTSC, PAL (Regionalcode 2)



Caution:

This unit is a class 1 laser product. However this unit uses a visible laser beam which could cause hazardous radiation exposure if directed. Be sure to operate the player correctly as instructed.

TECHNICAL SPECIFICATIONS

Specifications of the TV that you have just purchased may vary from the information in this table due to technical innovations.

TV Specifications

TV System	PAL/BG/DK/ I
Audio System	BG/DK/I
Screen size	22" [Diagonal]
Resolution	1920 x 1080 Pixels (RGB)
Aerial input	75 Ohm (unbalanced)
Audio output power	2 x 3W
Power requirements	12V  3A
Power consumption	22W
Standby power consumption	<0,5W
Weight	2.55kg

Remote control specifications

Type	Infrared
Control distance	5m
Control angle	30 degrees (Horizontal)
Batteries	2 x 1.5V, Size AAA
Dimensions	50 x 215 x 25mm
Weight	120g (without batteries)

Wall Mounting

1. The stand base and stand stem must be removed.
2. Please follow the instructions of how to apply the stand (included in the gift box), if you have already attached the TV stand read the instructions in reverse order to detach.
3. Be sure the stand stem is removed (unscrew 4 screws at the stem).
4. Use four machine screws to mount the TV on the bracket.

This unit is VESA-Compliant and designed to be wall mounted with a VESA-Compliant 100mm x 100 mm mounting kit. Mount this unit according to the instructions of the wall bracket (not supplied)

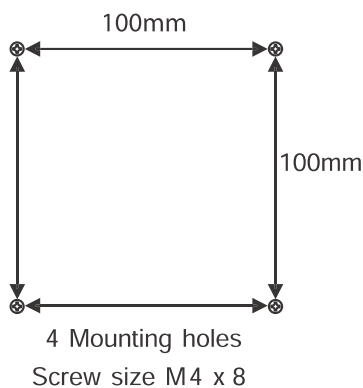

Waste Electrical Recycling

Correct disposal of Product



This sign indicates that this product may not be disposed of with your regular household waste. The recycling and separate collection of such products is your responsibility. Please drop off the above mentioned waste at a designated place for recycling waste electrical and electronic equipment. If you do not know where to drop off your waste equipment for recycling, please contact your local city office or household waste collection service.



The crossed out wheeled dust bin symbol indicates that batteries and/or accumulators must be collected and disposed of separately from household waste.

Hg Cd Pb



If the battery or accumulator contains more than the specified values of lead (Pb), mercury (Hg), and/or cadmium (Cd) defined in the Battery Directive (2006/66/EC), then the chemicals Hg Cd Pb symbols for lead(Pb), mercury (Hg) and/or cadmium (Cd) will appear below the crossed out wheeled dust bin symbol.

By participating in separate collection of batteries, you will help to assure the proper disposal of products and batteries thus help to prevent potential negative consequences for the environment and human health.

For more detailed information about the collection and recycling programmes available in your country, please contact your local city office or the shop where you purchased this product.



This appliance complies with European Safety and Electrical directives.

It fulfills the following EU regulations:

EN 55032:2015
 EN IEC6100-3-2:2019
 EN 6100-3-3:2013
 EN 55035:2017
 EN 60065:2014+A11:2017

